



BLOWER / ROUGH IN KITS SPECIFICATION SHEET

FEATURES

VINV300

- 120 VAC, 60 Hz, 3.0 A
- Interior mounted, single-wheel design blower - attaches to rough-in plate independent of hood
- Includes rough-in kit with 8-in. round damper/adaptor
- Uses 8-in. round duct

VINV600

- 120 VAC, 60 Hz, 3.0 A
- Interior mounted, single-wheel design blower - attaches to rough-in plate independent of hood
- Includes rough-in kit with 8-in. round damper/adaptor
- Uses 8-in. round duct

VINV1200

- 120 VAC, 60 Hz, 6.0 A
- Interior mounted, dual-wheel design blowers - attach to rough-in plate independent of hood
- Includes rough-in kit with 10-in. round inline damper
- Uses 10-in. round duct

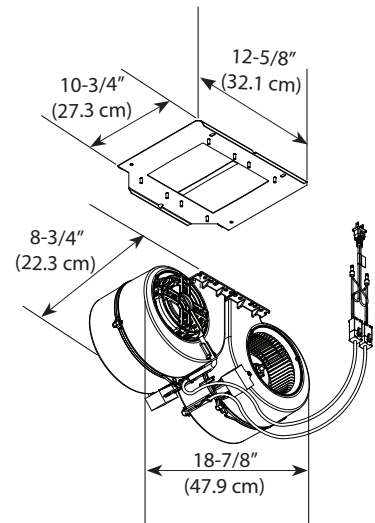
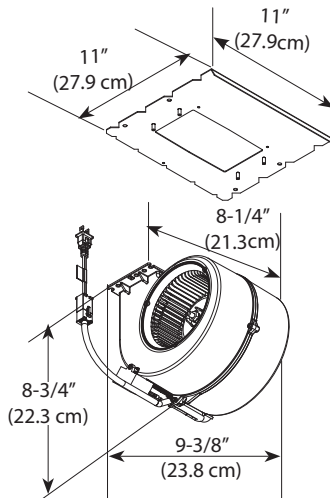
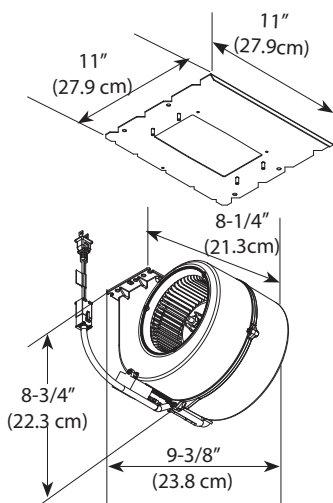

HVI-2100 CERTIFIED RATINGS comply with new testing technologies and procedures prescribed by the Home Ventilating Institute, for off-the-shelf products, as they are available to consumers. Product performance is rated at 0.1 in. static pressure, based on tests conducted in AMCA's state-of-the-art test laboratory. Sones are a measure of humanly-perceived loudness, based on laboratory measurements.



HVI PERFORMANCE

MODEL	DUCT ORIENTATION	SIZE	SONES		CFM		
			NORMAL	HIGH	NORMAL	HIGH 0.25 in. w.g.	HIGH 0.1 in. w.g.
VINV300	Round - Vertical	8"	<0.3	3.0	100	280	310
VINV600	Round - Vertical	8"	2.0	9.5	240	580	600
VINV1200	Round - Vertical	10"	2.0	11.0	440	1050	1090

Viking Range, LLC
 111 Front Street
 Greenwood, Mississippi 38930
 (662) 455-1200