

Laundry Center

use & care

Introduction.....	2	Operating Instructions	35
Important Safety Information	3	Stain Removal Guide.....	40
Features.....	8	Care and Cleaning	42
Pre-Installation Requirements.....	9	Troubleshooting	45
Installation	19	Limited Warranty	52
Accessories and Replacement Parts	27	Quebec Right to Repair.....	53
Controls And Settings.....	28		

2

INTRODUCTION

Welcome to our family

Thank you for bringing Frigidaire into your home! We see your purchase as the beginning of a long relationship together.

This manual is your resource for the Use & Care of your product. Please read it before using your appliance. Keep it handy for quick reference. If something doesn't seem right, the troubleshooting section will help you with common issues.

FAQs, helpful tips and videos, cleaning products, and kitchen and home accessories are available at www.frigidaire.com.

We are here for you! Visit our website, chat with an agent, or call us if you need help. We may be able to help you avoid a service visit. If you do need service, we can get that started for you.

Let's make it official! Be sure to register your product.

Keep your product info here so it's easy to find.

Model Number _____

Serial Number _____

Purchase Date _____

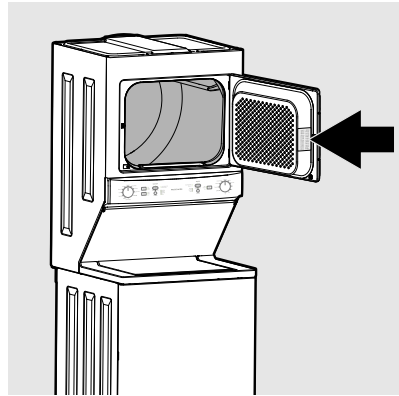

Serial Number Location



NOTE

The instructions appearing in this *Use & Care Manual* are not meant to cover every possible condition and situation that may occur. Common sense and caution must be practiced when installing, operating and maintaining any appliance.

READ ALL INSTRUCTIONS BEFORE OPERATING THIS APPLIANCE.

SAVE THESE INSTRUCTIONS FOR FUTURE REFERENCE.

 WARNING**FIRE or explosion hazard**

Failure to follow safety warning exactly could result in serious injury, death, or property damage.

DO NOT store or use gasoline or other flammable vapors and liquids in the vicinity of this or any other appliance.

WHAT TO DO IF YOU SMELL GAS:

- **DO NOT try to light any appliance.**
- **DO NOT touch any electrical switch; DO NOT use any phone in your building.**
- **Clear the room, building or area of all occupants.**
- **Immediately call your gas supplier from a neighbor's phone. Follow the gas supplier's instructions.**
- **If you cannot reach your gas supplier, call the fire department.**

Installation and service must be performed by a qualified installer, service agency or the gas supplier.

 DANGER

If using Liquid Propane (LP), STOP and install the LP kit before operating your gas dryer.



WARNING

Please read all instructions before using this laundry center.

This *Use & Care Guide* provides general operating instructions for your laundry center. It also contains information about features for several other models. Your model may not have every feature included.

Use the laundry center only as instructed in this *Use & Care Guide*.

This book contains valuable information about operation, care and service. Keep it in a safe place.



CAUTION

EXCESSIVE WEIGHT HAZARD

To avoid back or other injury, have more than one person move or lift the appliance.

Product record

Record Your Model and Serial Numbers

The model and serial numbers of your laundry center are found on the dryer serial plate located inside the door opening. Record and retain these numbers.

Model Number

Serial Number

Purchase Date

Child safety

Destroy or recycle the carton, plastic bags, and any exterior wrapping material immediately after the laundry center is unpacked. Children should never use these items to play. Cartons covered with rugs, bedspreads, plastic sheets or stretch wrap may become airtight chambers, and can quickly cause suffocation.

Proper disposal

Child entrapment and suffocation are not problems of the past. Junked or abandoned washers/dryers are still dangerous – even if they will sit for “just a few days”. If you are getting rid of your old washer/dryer, please follow the Risk of *Child Entrapment* section of the safety instructions to help prevent accidents.

Recognize safety symbols, words and labels

Safety items throughout this manual are labeled with a WARNING or CAUTION based on the risk type as described below:

Definitions

 This is the safety alert symbol. It is used to alert you to potential personal injury hazards. Obey all safety messages that follow this symbol to avoid possible injury or death.



DANGER

DANGER indicates an imminently hazardous situation which, if not avoided, will result in death or serious injury.



WARNING

WARNING indicates a potentially hazardous situation which, if not avoided, could result in death or serious injury.



CAUTION

CAUTION indicates a potentially hazardous situation which, if not avoided, may result in minor or moderate injury.



IMPORTANT

IMPORTANT indicates installation, operation or maintenance information which is important but not hazard-related.



WARNING

ELECTRIC SHOCK HAZARD

Certain internal parts are intentionally not grounded and may present a risk of electrical shock if contacted during installation. Do not contact the following parts while the appliance is energized:

- Pump
- Drive Motor
- Electronic control boards
- Water valve

IMPORTANT SAFETY INFORMATION



WARNING - risk of fire

To reduce the risk of fire, electrical shock, or injury to persons when using this laundry center, comply with the basic warnings listed below. Failure to comply with the Important Safety Information and WARNINGS could result in serious personal injuries or death.

Prevent fire

- DO NOT wash or dry items that have been previously cleaned in, soaked in, or spotted with gasoline, cleaning solvents, kerosene, cooking oils, waxes, etc. DO NOT store these items on or near the washer. These substances give off vapors or chemical reactions that could ignite or explode.
- DO NOT put oily or greasy rags or clothing on top of the laundry center. These substances give off vapors that could ignite the materials.
- DO NOT add gasoline, cleaning solvents, or other flammable or explosive substances to the wash water. These substances give off vapors that could ignite or explode.
- Under certain conditions, hydrogen gas may be produced in a hot water system that has not been used for 2 weeks or more. HYDROGEN GAS IS EXPLOSIVE. If the hot water system has not been used for such a period, turn on all hot water faucets and let the water flow from each for several minutes BEFORE using the washer. This will release any accumulated hydrogen gas. Hydrogen gas is flammable; DO NOT smoke or use an open flame during this time.
- DO NOT store or use gasoline, or other flammable liquids in the vicinity of this or any other appliance. Read product labels for warnings regarding flammability and other hazards.
- DO NOT place items exposed to cooking oils in your dryer. Items contaminated with cooking oils may contribute to a chemical reaction that could cause a load to catch fire. To reduce the risk of fire due to contaminated loads, the final part of a tumble dryer cycle occurs without heat (cool down period). Avoid stopping a tumble dryer before the end of the drying cycle unless all items are quickly removed and spread out so that the heat is dissipated.

- DO NOT dry articles containing rubber, plastic or similar materials such as bras, galoshes, bath mats, rugs, bibs, baby pants, plastic bags, and pillows that may melt or burn. Some rubber materials, when heated, can under certain circumstances produce fire by spontaneous combustion.
- Clean the lint filter before or after each load. **The interior of the dryer, lint filter housing, and exhaust duct should be cleaned approximately every 18 months by a qualified service professional.** An excessive amount of lint build-up in these areas could result in inefficient drying and possible fire. *See Care and Cleaning.*
- DO NOT operate the dryer if the lint filter is blocked, damaged or missing. Fire hazard, overheating, and damage to fabrics can occur.



WARNING

FIRE HAZARD

A clothes dryer produces combustible lint. The dryer must be connected to an outdoors exhaust. Regularly inspect the outdoor exhaust opening and remove any accumulation of lint around the opening and in the surrounding area.

- DO NOT operate the appliance in the presence of explosive fumes.
- DO NOT obstruct the flow of ventilating air. DO NOT stack or place laundry or throw rugs against the front or back of the dryer.
- DO NOT spray any type of aerosol into, on or near dryer at any time.
- DO NOT use fabric softeners or products to eliminate static unless recommended by the manufacturer of the fabric softener or product.
- DO NOT continue to use the laundry center if you hear squeaking, grinding, rubbing or other unusual noises. This could be a sign of mechanical breakdown and lead to fire or serious injury. Contact a qualified technician immediately.
- Failure to comply with these warnings could result in fire, explosion, serious bodily injury, and/or damage to the rubber or plastic parts of the laundry center.

6

IMPORTANT SAFETY INFORMATION

Protect children

- DO NOT allow children to play on or in the laundry center. Close supervision of children is necessary when the laundry center is used near children. As children grow, teach them the proper, safe use of all appliances.
- Destroy or recycle the carton, plastic bag, and other packing materials after the laundry center is unpacked. Children might use them for play. Cartons covered with rugs, bedspreads or plastic sheets can become airtight chambers.
- Keep laundry products out of children's reach. To prevent personal injury, observe all warnings on product labels.
- Before the laundry center is removed from service or discarded, remove the washer and dryer doors to prevent accidental entrapment.
- Failure to comply with these warnings could result in serious personal injuries.

Risk of child entrapment

Child entrapment and suffocation are not problems of the past. Junked or abandoned washer and dryers are still dangerous – even if they will sit for “just a few days”. If you are getting rid of your old washer or dryer, please follow the instructions below to help prevent accidents.

We strongly encourage responsible appliance recycling/disposal methods. Contact your State/Province Energy Office, Local Electric and Water Utilities or Conservation Program Office or visit www.energystar.gov/recycle for more information on recycling your old washer or dryer.

Before you throw away your old washer or dryer:

- Remove doors.
- Remove the electric power cord.
- Secure all hoses and drain pipes to prevent water from leaking out and creating a slip hazard.

Prevent injury

- To prevent shock hazard and assure stability during operation, the laundry center must be installed and electrically grounded by a qualified service person in accordance with local codes. Installation instructions are packed in the washer for installer's reference. Refer to *Installation* section for detailed grounding procedures. If the laundry center is moved to a new location, have it checked and reinstalled by a qualified service person.

- To prevent personal injury or damage to the laundry center, the electrical power cord of a gas dryer must be plugged into a properly grounded and polarized 3-prong outlet. The third grounding prong must never be removed. Never ground the dryer to a gas pipe. DO NOT use an extension cord or an adapter plug.
- ALWAYS disconnect the laundry center from the electrical supply before attempting any service or cleaning. Failure to do so can result in electrical shock or injury.
- DO NOT use any type spray cleanser when cleaning dryer interior. Hazardous fumes or electrical shock could occur.
- To prevent injury, DO NOT reach into the laundry center while parts are moving. Before loading, unloading or adding items, push in the cycle selector knob to stop the cycle. Allow the wash tub or dryer drum to coast to a complete stop before reaching inside.
- The lid will remain locked for up to 6 minutes after the cycle ends, to allow the wash tub to stop spinning.
- Follow package directions when using laundry products. Incorrect usage can produce poisonous gas - resulting in serious injury or death.
- DO NOT combine laundry products for use in 1 load unless specified on the label.
- DO NOT mix chlorine bleach with ammonia or acids such as vinegar.



WARNING

HARMFUL VAPOR HAZARD

DO NOT use or mix liquid chlorine bleach with other household chemicals such as toilet cleaners, rust removers, acids such as vinegar, or products containing ammonia. These mixtures can produce dangerous fumes which can cause serious injury or death.



Prevent injury and damage to the appliance

To prevent serious personal injury and damage to the laundry center:

- All repairs and servicing must be performed by an authorized service agent unless specifically recommended in this *Use & Care Guide*. Use only authorized factory parts.
 - DO NOT tamper with controls.
 - DO NOT install or store the laundry center where it will be exposed to the weather. DO NOT operate the laundry center in below freezing temperatures.
 - DO NOT install on carpet. Install laundry center on a solid floor. It may be necessary to reinforce the floor to prevent vibration or movement.
 - DO NOT sit on, step on or stand on the laundry center. DO NOT rest heavy loads on top. The laundry center is not meant to support weight.
- To reduce the risk of electric shock, disconnect this appliance from the power supply before attempting any user maintenance. Canceling a cycle or turning the power off at the console does not disconnect this appliance from the power supply.
 - This laundry center is equipped with an electrical overload protector. The washer motor will stop if it becomes overheated.
 - A thermal limiter switch automatically turns off the dryer motor in the unlikely event of an overheated situation. A service technician must replace the thermal limiter switch after correcting the fault.
 - Failure to comply with these warnings could result in property damage or serious personal injuries.
 - Do not use replacement parts that have not been recommended by the manufacturer (e.g. parts made at home using a 3D printer).



WARNING

FIRE/ELECTRICAL SHOCK HAZARD

Avoid fire hazard or electrical shock. DO NOT use an adapter plug or extension cord or remove grounding prong from electrical power cord. Failure to follow this warning can cause serious injury, fire, or death.

208 v/240 v Electric Dryer

10-30R 3-wire (fused 30 amp)

14-30R 4-wire (fused 30 amp)

UL-approved service cord must be installed on electric dryers (not provided with unit except those manufactured for sale in Canada).

Grounding type wall receptacle

120 v Gas Dryer

Do not, under any circumstances, cut, remove, or bypass the grounding prong.

Power cord with 3-prong grounded plug

8

FEATURES

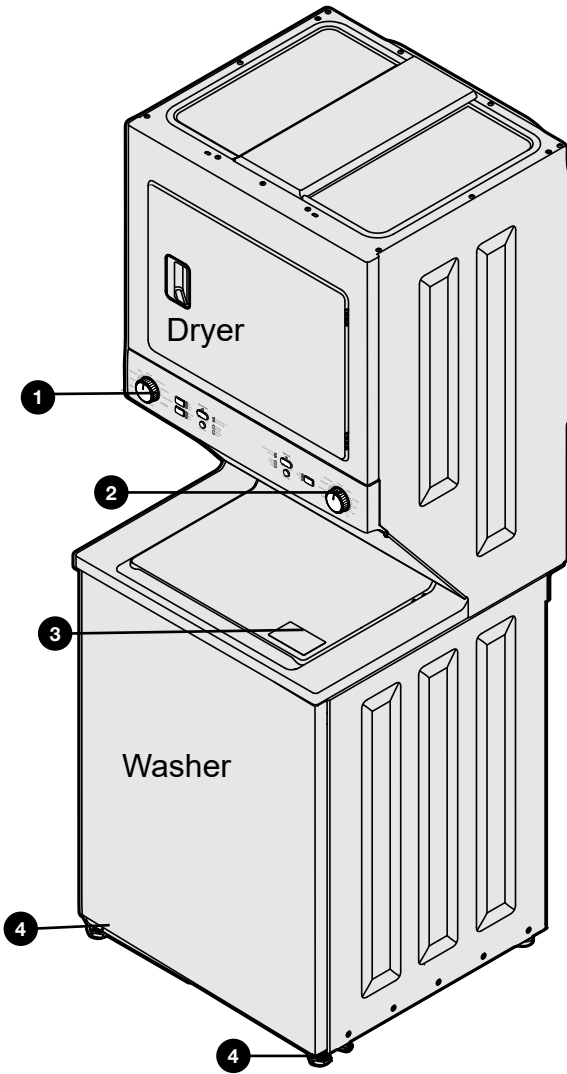

1. Washer Controls
2. Dryer Controls

3. Washer Lid Lock Location
4. Leveling Leg



Installation Checklist

Shipping hardware

- Foam shipping restraint (inside wash tub) removed and stored
- Foam shipping support (underneath appliance) removed and stored

Leveling

- Laundry center is level, side-to-side and front-to-back
- Cabinet is sitting solid on all corners

Water supply

- Use only new hoses and verify rubber sealing washers are installed
- HOT supply is connected to HOT inlet and COLD supply is connected to COLD inlet
- HOT and COLD water supply turned on
- No leaks present at water supply connections or appliance inlet connections-recheck after 24 hours

Drain

- Stand pipe or wall drain height min. 33"
- Drain hose secured in place with cable tie (shipped in drum)

Exhaust venting

- Free-flowing, clear of lint buildup
- 4 inch (102 mm) rigid or semi-rigid ducting of minimal length and turns
- NO foil or plastic venting material**
- Approved vent hood exhausted to outdoors

Gas supply (Gas Dryer)

- Manual shutoff valve present in supply
- All connections sealed with approved sealer and wrench tight
- Conversion kit for LP system (*P/N 5304523143 not included)
- Gas supply turned on
- No leaks present at all connections - check with soapy water, NEVER check with flame

208v/240V electric supply (electric dryer)

- Approved NEMA 10-30 or 14-30 service cord with all screws tight on terminal block
- Approved strain relief installed
- Terminal access cover installed before initial operation

Electrical power

- House power turned on
- Laundry Center plugged in

Final checks

- Installation Instructions and Use & Care Guide read thoroughly
- Water enters drum when cycle starts with lid lowered
- Dryer door latches and drum tumbles when cycle starts
- Registration card sent in

Tool requirements

Tools and materials needed for installation:

- Adjustable pliers
- Phillips, straight, & square bit screwdrivers
- Adjustable wrench
- Pipe wrench for gas supply (gas dryer)
- LP-resistant thread tape (for natural gas or LP supply, gas dryer)
- Carpenter's level
- External vent hood
- 4-inch (102 mm), rigid metal or semi-rigid metal exhaust duct work
- 3-wire or 4-wire 240 volt cord kit (electric dryer)
- 4 in. (102 mm) clamp
- Gas line shutoff valve (gas dryer)
- 1/2 NPT union flare adapters (x2) and flexible gas supply line (gas dryer)
- Metal foil tape (not duct tape)
- Inlet hoses (x2)



NOTE

Hoses are not included with washer purchase.

10

PRE-INSTALLATION REQUIREMENTS

Electrical system requirements



NOTE

Because of potentially inconsistent voltage capabilities, the use of this dryer with power created by gas powered generators, solar powered generators, wind powered generators or any other generator other than the local utility company is not recommended.

Electrical requirements for laundry center with electric dryer

CIRCUIT - Individual 30 amp. branch circuit fused with 30 amp. time delay fuses or circuit breakers.

POWER SUPPLY - 3-wire or 4-wire, 240 volt, single phase, 60 Hz, Alternating Current.



IMPORTANT

This laundry center is internally grounded to neutral unless it was manufactured for sale in Canada. Only a 4-conductor cord shall be used when the appliance is installed in a location where grounding through the neutral conductor is prohibited. Grounding through the neutral link is prohibited for: (1) new branch circuit installations, (2) mobile homes, (3) recreational vehicles, and (4) areas where local codes DO NOT permit grounding through the neutral.

OUTLET RECEPTACLE - NEMA 10-30R or NEMA 14-30R receptacle to be located so the power supply cord is accessible when the dryer is in the installed position.

GROUNDING CONNECTION - See "Grounding requirements" in Electrical Installation section.



WARNING

Improper grounding of the laundry center may cause serious injury or death. Check with a licensed electrician if you are in doubt as to whether the appliance is properly grounded.

Grounding type wall receptacle

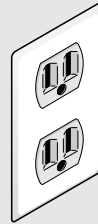

Do not, under any circumstances, cut, remove, or bypass the grounding prong.

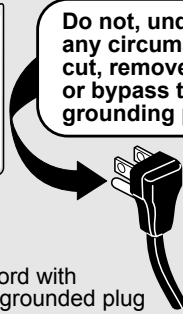

Power cord with 3-prong grounded plug

3-Wire power supply cord kit (not supplied)



3-wire receptacle (NEMA type 10-30R)

The dryer **MUST** employ a 3-conductor power supply cord NEMA 10-30 type SRDT rated at 240 volt AC minimum, 30 amp, with 3 open end spade lug connectors with upturned ends or closed loop connectors and marked for use with clothes dryers. For 3-wire cord connection instructions see ELECTRICAL CONNECTIONS FOR A 3-WIRE SYSTEM.

4-Wire power supply cord kit (not supplied)



4-wire receptacle (NEMA type 14-30R)

The dryer **MUST** employ a 4-conductor power supply cord NEMA 14-30 type SRDT or DRT (as required) rated at 240 volt AC minimum, 30 amp, with 4 open end spade lug connectors with upturned ends or closed loop connectors and marked for use with clothes dryers. For 4-wire cord connection instructions see ELECTRICAL CONNECTIONS FOR A 4-WIRE SYSTEM.



NOTE

Laundry centers manufactured for sale in Canada have factory-installed, 4-wire power supply cord (NEMA 14-30).

PRE-INSTALLATION REQUIREMENTS

Electrical requirements for laundry center with gas dryer



WARNING

Improper grounding of the laundry center may cause serious injury or death. Check with a licensed electrician if you are in doubt as to whether the appliance is properly grounded.

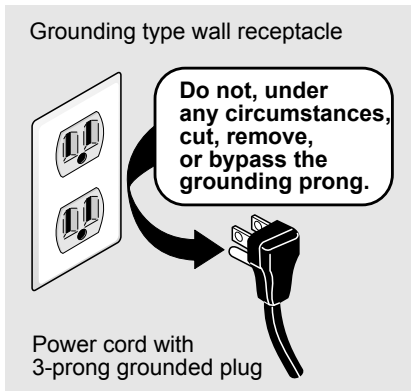

CIRCUIT - Individual, properly polarized and grounded 15 amp. branch circuit fused with 15 amp. time delay fuse or circuit breaker.

POWER SUPPLY - 2-wire, with ground, 120 volt, single phase, 60 Hz, Alternating Current.

POWER SUPPLY CORD - The dryer is equipped with a 120 volt 3-wire power cord.

GROUNDING CONNECTION - See "Grounding requirements" in Electrical Installation section.

Gas supply requirements



WARNING

EXPLOSION HAZARD

Uncoated copper tubing will corrode when subjected to natural gas, causing gas leaks. Use **ONLY** black iron, stainless steel, or plastic-coated brass piping for gas supply.

1. Installation **MUST** conform with local codes, or in the absence of local codes, with the National Fuel Gas Code, ANSI Z223.1 (latest edition).
2. The gas supply line should be 1/2 inch (1.27 cm) pipe.
3. If codes allow, flexible metal tubing may be used to connect your dryer to the gas supply line. The tubing **MUST** be constructed of stainless steel or plastic-coated brass.
4. The gas supply line **MUST** have an individual shutoff valve installed in accordance with the B149.1, Natural Gas and Propane Installation Code.
5. A 1/8 inch (0.32 cm) N.P.T. plugged tapping, accessible for test gauge connection, **MUST** be installed immediately upstream of the gas supply connection to the dryer.
6. The dryer **MUST** be disconnected from the gas supply piping system during any pressure testing of the gas supply piping system at test pressures in excess of 1/2 psig (3.45 kPa).
7. The dryer **MUST** be isolated from the gas supply piping system during any pressure testing of the gas supply piping system at test pressures equal to or less than 1/2 psig (3.45 kPa).
8. Connections for the gas supply must comply with the Standard for Connectors for Gas Appliances, ANSI Z21.24 - CSA 6.10.

Water supply requirements

Hot and cold water faucets **MUST** be installed within 42 inches (107 cm) of your washer's water inlet. The faucets **MUST** be 3/4 inch (1.9 cm) with threading for laundry hose connection. Water pressure **MUST** be between 10 psi (0.69 bars) and 120 psi (8.27 bars). Pressure difference between hot and cold cannot be more than 10 psi. Your water department can advise you of your water pressure.



NOTE

Washers connected to water supplies with lower inlet pressure will experience longer filling times and may not complete cycles as quickly.

Drain system requirements

1. Drain capable of eliminating 17 gals (64.3 L) per minute.
2. A standpipe diameter of 1-1/4 in. (3.18 cm) minimum.
3. Standpipe height above the floor should be:
Minimum height: 33 in. (84 cm)
Maximum height: 96 in. (244 cm)

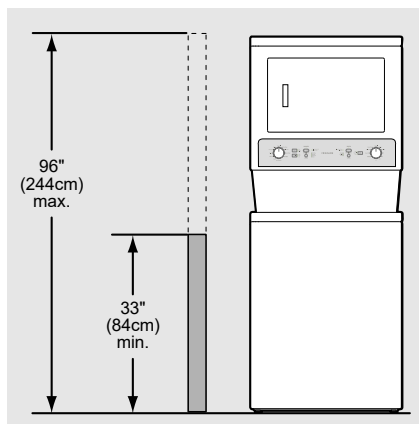

NOTE

For installations requiring a longer drain hose, have a qualified technician install a longer drain hose (according to your model number) available from an authorized parts distributor. For drain systems in the floor, install a siphon break kit available from your local hardware store.

Exhaust system requirements

Duct work requirements

Use only 4 inch (102 mm) diameter rigid or flexible metal duct and approved vent hood which has a swing-out damper(s) that open when the dryer is in operation. When the dryer stops, the dampers automatically close to prevent drafts and the entrance of insects and rodents. To avoid restricting the outlet, maintain a minimum of 12 inches (30.5 cm) clearance between the vent hood and the ground or any other obstruction.



WARNING

FIRE HAZARD

Failure to follow these instructions can create excessive drying times and fire hazards.

The following are specific requirements for proper and safe operation of your dryer.



WARNING

FIRE HAZARD

DO NOT install a clothes dryer with flexible plastic or metal foil venting materials. Flexible venting materials are known to collapse, be easily crushed and trap lint. These conditions will obstruct clothes dryer airflow and increase the risk of fire.

If your present system is made up of plastic duct or metal foil duct, replace it with a rigid or semi-rigid metal duct. Also, ensure the present duct is free of any lint prior to installing dryer duct.

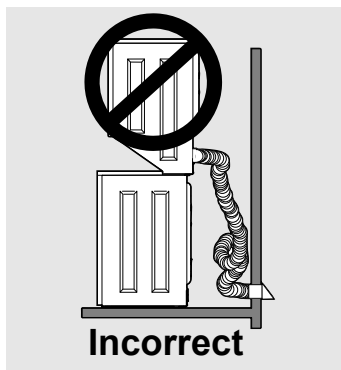
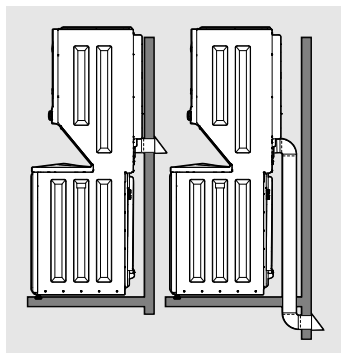



WARNING

FIRE HAZARD

A clothes dryer must be exhausted outdoors. DO NOT exhaust dryer into any gas vent, a chimney, a wall, a ceiling, an attic, a crawl space or any concealed space of a building. A clothes dryer produces combustible lint. If the dryer is not exhausted outdoors, some fine lint will be expelled into the laundry area. An accumulation of lint in any area of the home can create a health and fire hazard.

The dryer must be connected to an exhaust outdoors. **Prior to installing your new dryer**, inspect the outdoor exhaust opening and remove any accumulation of lint around the outdoor exhaust opening and in the surrounding area.



WARNING

FIRE HAZARD

- DO NOT allow combustible materials (for example: clothing, draperies/curtains, paper) to come in contact with exhaust system. The dryer MUST NOT be exhausted into any gas vent, a chimney, a wall, a ceiling, or any concealed space of a building which can accumulate lint, resulting in a fire hazard.

- DO NOT screen the exhaust ends of the vent system, or use any screws, rivets or other fasteners that extend into the duct to assemble the exhaust system. **No screen, grate, or guard of any mesh**

size is allowed to cover the exhaust opening. Lint can become caught in the screen, grate, guard, or on the screws or rivets, clogging the duct work and creating a fire hazard as well as increasing drying times.



Use an approved vent hood to terminate the duct outdoors, and seal all joints with metal foil tape. All male duct pipe fittings MUST be installed downstream with the flow of air.



WARNING

FIRE HAZARD



Failure to follow safety warnings exactly could result in serious injury, death, or property damage. DO NOT install a booster fan in the exhaust duct. Install ALL clothes dryers in accordance with the installation instructions in this manual.



WARNING

FIRE HAZARD

Never exceed more than 3 - 90 elbows (Standard Vent) and 4 -90 elbows (Long Vent Models Only) in the exhaust duct system. Exceeding the length of duct pipe or number of elbows allowed in the "MAXIMUM LENGTH" charts can cause an accumulation of lint in the exhaust system. Plugging the system could create a fire hazard, as well as increase drying times.

Max. Number of 90° turns	MAXIMUM LENGTH of 4" (102 mm) Rigid Metal Duct		
	STANDARD VENT MODELS		
	VENT HOOD TYPE		
			
	4" (10.2 cm)	louvered	2.5" (6.35 cm)
0	56 ft. (17 m)		42 ft. (13 m)
1	48 ft. (14.5 m)		34 ft. (10.5 m)
2	40 ft. (12 m)		26 ft. (8 m)
3	32 ft. (9.5 m)		18 ft. (5.5 m)





WARNING

FIRE HAZARD

To prevent the Risk of Fire, use only the recommended exhaust duct length chart provided by the manufacturer for your specific model. Use Long Vent duct lengths ONLY on laundry center models identified as LONG VENT. Standard Vent models are NOT designed to operate using Long Vent exhaust duct lengths.

14

PRE-INSTALLATION REQUIREMENTS

Max. Number of 90° turns	MAXIMUM LENGTH of 4" (102 mm) Rigid Metal Duct	
	LONG VENT MODELS ONLY FLCE7523AW	
	VENT HOOD TYPE	
	 4" (10.2 cm)	 louvered
	 2.5" (6.35 cm)	
0	127 ft. (39 m)	124 ft. (37 m)
1	117 ft. (35 m)	114 ft. (34 m)
2	107 ft. (32 m)	104 ft. (31 m)
3	97 ft. (29 m)	94 ft. (28 m)
4	87 ft. (26 m)	84 ft. (25 m)

In installations where the exhaust system is not described in the charts, the following method must be used to determine if the exhaust system is acceptable:

1. Connect an inclined or digital manometer between the dryer and the point the exhaust connects to the dryer.
2. Set the dryer timer and temperature to air fluff (cool down) and start the dryer.
3. Read the measurement on the manometer.
4. Vent Models

Standard Vent Model:

The system backpressure MUST NOT be higher than 0.6 inches of water column. If the system back pressure is less than 0.6 inches of water column, the system is acceptable. If the manometer reading is higher than 0.6 inches of water column, the system is too restrictive and the installation is unacceptable

Long Vent Model - FLCE7523AW:
The system backpressure MUST NOT be higher than 1.4 inches of water column. If the system back pressure is less than 1.4 inches of water column, the system is acceptable. If the manometer reading is higher than 1.4 inches of water column, the system is too restrictive and the installation is unacceptable

Although vertical orientation of the exhaust system is acceptable, certain extenuating circumstances could affect the performance of the dryer:

- Only rigid metal duct work should be used.
- Venting vertically through a roof may expose the exhaust system to down drafts causing an increase in vent restriction.
- Running the exhaust system through an uninsulated area may cause condensation and faster accumulation of lint.
- Compression or crimping of the exhaust system will cause an increase in vent restriction.



WARNING

FIRE HAZARD

- DO NOT install flexible plastic or flexible foil venting material.
- If installing semi-rigid venting, DO NOT exceed 8 ft. (2.4 m) duct length.



WARNING

FIRE HAZARD

- Failure to follow safety warnings exactly could result in serious injury, death, or property damage.
- DO NOT install a booster fan in dryer exhaust duct.
- Install all clothes dryers in accordance with the installation instructions in this manual.

Install male fittings in correct direction:

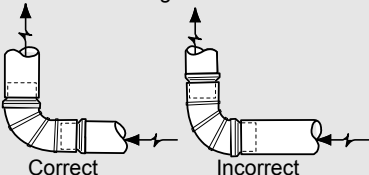

Correct

Incorrect

- The exhaust system should be inspected and cleaned a minimum of every 18 months with normal usage. The more the dryer is used, the more often you should check the exhaust system and vent hood for proper operation.

Rear flush exhaust requirements

The laundry center may be exhausted four (4) ways with rear flush installation:

- Straight back with articulating elbow back.
- Down with articulating elbow down.
- Left with articulating elbow left.
- Right with articulating elbow right.

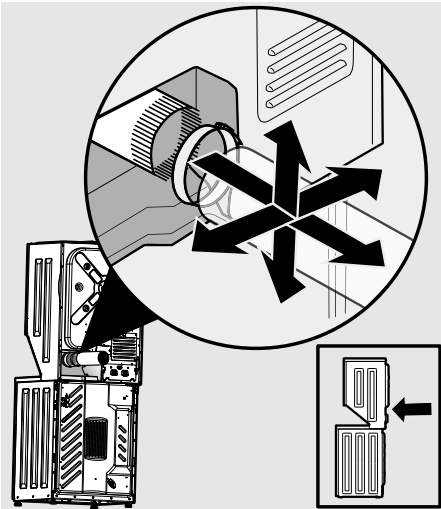

An exhaust hood positioned to line up with the dryer exhaust can be installed directly through the outside wall. To exhaust to the side or down, add an 8 inch (20.3 cm) length of standard 4 inch (102 mm) diameter duct and a 90° elbow.

To exhaust up, add an 11 inch (28 cm) length of standard 4 inch (102 mm) diameter duct and a 90° elbow. The unit will be positioned about 4.5 inches (11.5 cm) away from the wall (flush to wall exhausting may be done by going below the dryer then sideways).

See also Clearance Requirements in this instruction.

Manufactured or mobile home installation

- Installation MUST conform to current Manufactured Home Construction & Safety Standard, Title 24 CFR Part 3280 (formerly the Federal Standard for Mobile Home Construction and Safety, Title 24, HUD Part 280) or Standard CAN/CSA-Z240 MH.
- Dryer MUST be exhausted outside (outdoors, not beneath the mobile home) using metal ducting that will not support combustion. Metal ducting must be 4 inches (10.16 cm) in diameter with no obstructions. Rigid metal duct is preferred. Exhaust ducts must be securely fastened to a noncombustible portion of the mobile home structure.
- If dryer is exhausted through the floor and area beneath the mobile home is enclosed, the exhaust system MUST terminate outside the enclosure with the termination securely fastened to the mobile home structure.
- Refer to previous sections in this guide for other important exhaust venting system requirements.
- When installing a gas dryer into a mobile home, a provision must be made for outside make up air. This provision is to be not less than twice the area of the dryer exhaust outlet.
- Installer MUST anchor this laundry center to the floor with approved Mobile Home Installation Kit - P/N 137067200.

Installation in a recess or closet

1. A dryer installed in a recess or closet, MUST be exhausted outdoors.
2. No other fuel burning appliance shall be installed in the same recess or closet as a gas dryer.
3. Your dryer needs space around it for proper ventilation. See "Clearance Requirements" chart.
4. A minimum of 120 square inches of inlet ventilation opening to the recess or closet is required for proper air flow to the dryer.
5. Inlet air ventilation to the recess or closet can be satisfied by adding 120 square inches of opening, equally divided at the top and bottom of the door and located 3 inches from the bottom and top of the door.
or, Adding 120 square inches of ventilation openings to the top, sides or rear wall of the closet wall, if the wall is adjacent to an open room, hallway, or exterior.

or, A louvered door with equivalent air openings equaling 120 sq. inches of ventilation for the full length of the door is acceptable.

It is **NOT** approved to derive the 120 sq. inches of ventilation from the space between the door edges and the casing or the floor.

** The presence of forced heating and air-conditioning vent openings in the closet does NOT satisfy the 120 square inch ventilation requirement to the closet.

Ventilation Examples

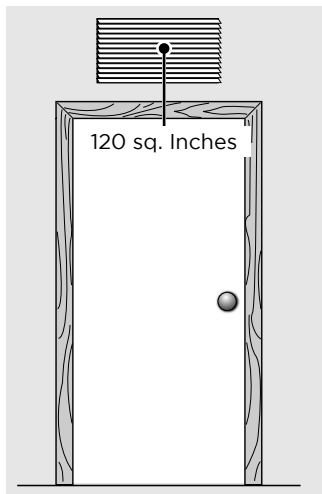

Solid Door with Wall Ventilation

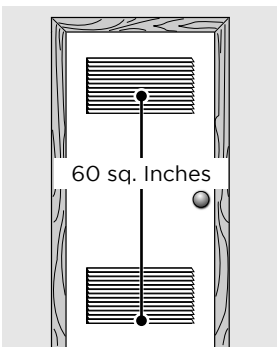

120 sq. Inches Equally Divided Split Vent Door

120 sq. Inches min. Louvered Opening

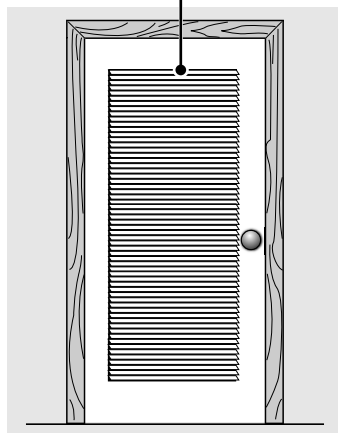

Louvered Door

Clearance requirements

MINIMUM INSTALLATION CLEARANCES - Inches (cm)				
	SIDES	REAR	TOP	FRONT
Alcove/ recess	0" (0 cm)	0" (0 cm)	0" (0 cm)	Open
Closet w/Door Vent	0" (0 cm)	0" (0 cm)	1" (0 cm)	1" (2.5cm)
Closet w/Wall Vent	1" (2.5 cm)	1" (2.5cm)	1" (2.5cm)	1" (2.5cm)

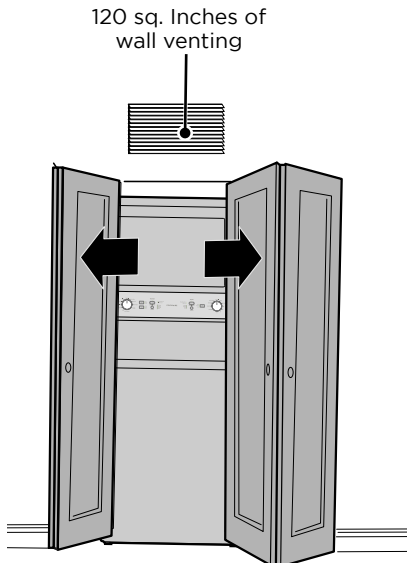

Solid Bi-Fold doors with no ventilation



WARNING

EXPLOSION HAZARD

DO NOT install the laundry center where gasoline or other flammables are kept or stored. If the laundry center is installed in a garage, the dryer portion must be a minimum of 18 inches (45.7 cm) above the floor. Failure to do so can result in death, explosion, fire or burns.



IMPORTANT

DO NOT INSTALL YOUR LAUNDRY CENTER:

- In an area exposed to standing water, dripping water, or outside weather conditions. The ambient temperature should never be below 60° F (15.6° C) to maximize detergent effectiveness.
- In an area where it will come in contact with curtains, drapes, or anything that will obstruct the flow of combustion and ventilation air.
- On carpet. Floor MUST be solid with a maximum slope of 1 inch (2.5 cm). To minimize vibration or movement, reinforcement of the floor may be necessary.

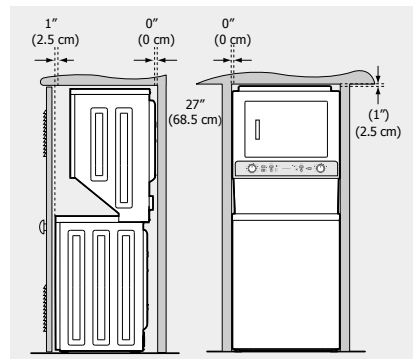

Laundry center dimensions

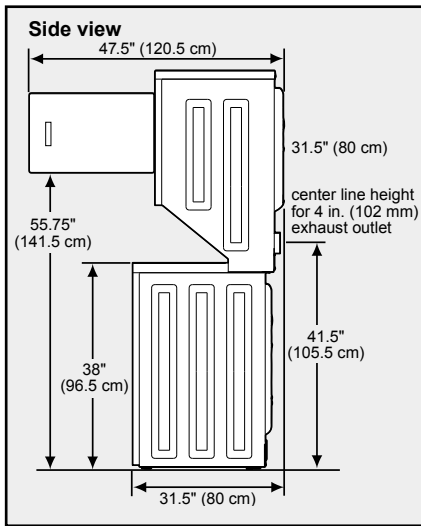
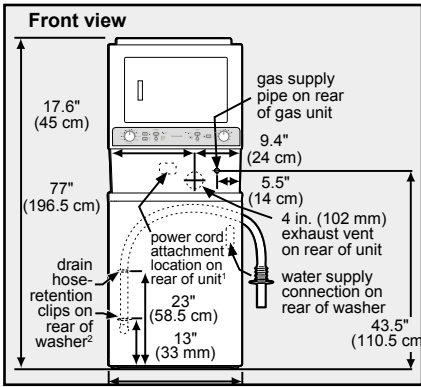

¹ Power supply cord length on gas unit approximately 60 inches (152.5 cm).

² Loose drain hose length beyond clamp approximately 51.5 inches (131 cm).

³ Door opens in reverse direction than shown above on long vent models.

Unpacking instructions



IMPORTANT

To prevent vibration, possible machine damage and maximize performance, the following steps must be completed.

1. If foam tub block has been removed, reinsert it now and tape the lid securely.

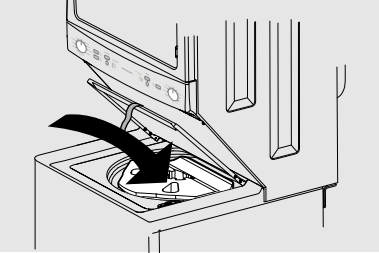

2. Carefully cut the front and back corners of the left side of the remaining cardboard.

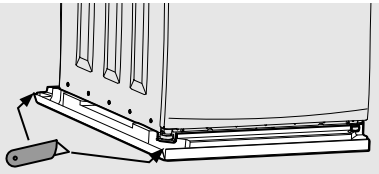

3. With help from a second person, carefully tip the laundry center slightly to the left as shown in the picture below. Remove the foam shipping support from the base of the unit. Save packaging foam for future use.

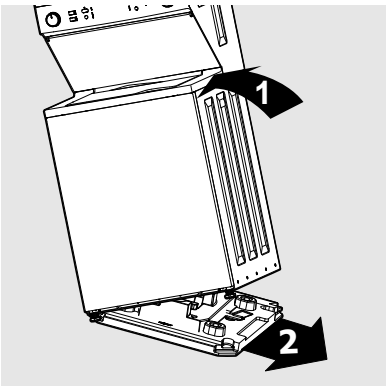

4. Carefully lower the laundry center to an upright position and remove the tape holding the lid shut. Remove the foam tub block, all foam inserts, and other tub contents.

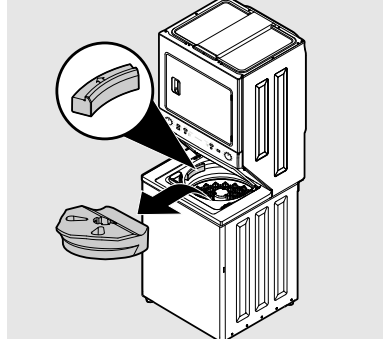

NOTE

If the laundry center is to be transported at a later date, the tub blocking pad, foam base and tub support should be retained.

5. From the back of the washer, remove the wire shipping clips securing the drain hose.
6. DO NOT remove the PLASTIC CLIPS which secure the drain hose to the right side of the washer back sheet. It helps form a standpipe to prevent water siphoning.

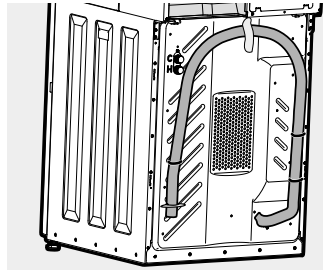

7. Carefully move the laundry center to within four (4) feet of the final location for the start of the installation.



CAUTION

EXCESSIVE WEIGHT HAZARD

To avoid back or other injury, have more than one person move or lift the appliance.

20 INSTALLATION

Connecting the gas

This gas dryer comes from the factory with natural gas burner components installed. DO NOT operate this gas dryer, using LP (liquid propane) gas, unless the LP gas conversion kit has been properly installed by a qualified service personnel. Improper gas installation or LP conversion kit installation could result in injury or even death.

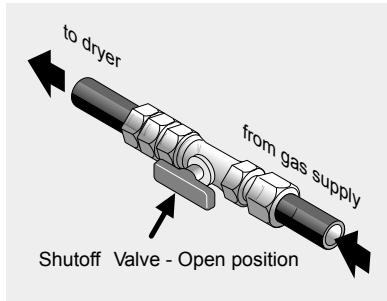

IMPORTANT

DO NOT connect the dryer to L.P. gas service without converting the gas valve. An L.P. conversion kit must be installed by a qualified gas technician.

1. Remove the shipping cap from gas pipe at the rear of the dryer.
2. Connect a 1/2 inch (1.27 cm) I.D. semi-rigid or approved pipe from gas supply line to the 3/8 inch (0.96 cm) pipe located on the back of the dryer. Use a 1/2 inch to 3/8 inch (1.27 cm to 0.96 cm) reducer for the connection. Apply an approved thread sealer that is resistant to the corrosive action of liquefied gases on all pipe connections.

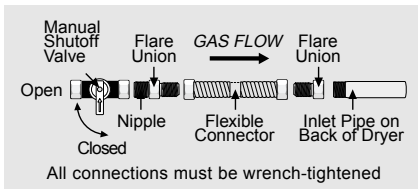

IMPORTANT

The supply line must be equipped with an approved manual shutoff valve. This valve should be located in the same room as the dryer and should be in a location that allows ease of opening and closing. DO NOT block access to the gas shutoff valve.

3. Open the shutoff valve in the gas supply line to allow gas to flow through the pipe. Wait a few minutes for gas to move through the gas line.

4. Check for gas system leaks with a manometer. If a manometer is not available, test all connections by brushing on a soapy water solution.



WARNING

EXPLOSION HAZARD

NEVER test for gas leaks with an open flame.

Connecting the electrical system

The following are specific requirements for proper and safe electrical installation of your dryer. Failure to follow these instructions can create electrical shock and/or a fire hazard.



WARNING

ELECTRICAL SHOCK HAZARD

- This appliance MUST be properly grounded. Electrical shock can result if the dryer is not properly grounded. Follow the instructions in this manual for proper grounding.
- DO NOT use an extension cord with this dryer. Some extension cords are not designed to withstand the amounts of electrical current this dryer utilizes and can melt, creating electrical shock and/or fire hazard. Locate the dryer within reach of the receptacle for the length power cord to be purchased, allowing some slack in the cord. Refer to the pre-installation requirements in this manual for the proper power cord to be purchased.

**WARNING****ELECTRICAL SHOCK HAZARD**

- A U.L.-approved strain relief must be installed onto power cord. If the strain relief is not attached, the cord can be pulled out of the dryer and can be cut by any movement of the cord, resulting in electrical shock.
- DO NOT use an aluminum wired receptacle with a copper wired power cord and plug (or vice versa). A chemical reaction occurs between copper and aluminum and can cause electrical shorts. The proper wiring and receptacle is a copper wired power cord with a copper wired receptacle.

**NOTE**

A 208 or 240v, single phase 60Hz, Alternating Current power supply should be used on electric dryer models as indicated on rating plate. A 120v single phase 60Hz Alternating Current power supply should be used on gas dryer models as indicated on rating plate.

**NOTE**

Dryers operating on 208 volt power supply will have longer drying times than dryers operating on 240 volt power supply.

**NOTE**

The electric dryer has been designed and certified to operate at both 240V and 208V. Drying times on a 208V power supply will, however, be approximately 20% longer than drying times on a 240V power supply. This is normal and expected behavior and applies to all drying cycles.

Grounding the electric dryer (USA)**WARNING**

Improper grounding of the laundry center may cause serious injury or death. Check with a licensed electrician if you are in doubt as to whether the appliance is properly grounded.

For a grounded, cord-connected dryer:

1. The dryer **MUST** be grounded. In the event of a malfunction or breakdown, grounding will reduce the risk of electrical shock by a path of least resistance for electrical current.
2. After you purchase and install a 3-wire or 4-wire power supply cord having an equipment-grounding conductor and a grounding plug that matches your wiring system, the plug **MUST** be plugged into an appropriate, copper wired receptacle that is properly installed and grounded in accordance with all local codes and ordinances. If in doubt, call a licensed electrician.
3. DO NOT modify the plug you've installed on this appliance. If it will not fit the outlet, have a proper outlet installed by a qualified electrician.

For a permanently connected dryer:

The dryer **MUST** be connected to a grounded metal, permanent wiring system; or an equipment grounding conductor must be run with the circuit conductors and connected to the equipment-grounding terminal or lead on the appliance.

Grounding the electric dryer (Canada)**WARNING**

Improper grounding of the laundry center may cause serious injury or death. Check with a licensed electrician if you are in doubt as to whether the appliance is properly grounded.

22 INSTALLATION

For a grounded, cord-connected dryer:

1. The laundry center **MUST** be grounded. In the event of a malfunction or breakdown, grounding will reduce the risk of electrical shock by a path of least resistance for electrical current.
2. Since your laundry center is equipped with a power supply cord having an equipment-grounding conductor and a grounding plug, the plug must be plugged into an appropriate outlet that is properly installed and grounded in accordance with all local codes and ordinances. If in doubt, call a licensed electrician.
3. **DO NOT** modify the plug provided with this appliance. If it will not fit the outlet, have a proper outlet installed by a qualified electrician.

2. The plug must be plugged into an appropriate outlet that is properly installed and grounded in accordance with all local codes and ordinances. If in doubt, call a licensed electrician.
3. **DO NOT** modify the plug provided with this appliance. If it will not fit the outlet, have a proper outlet installed by a qualified electrician.

Electrical connection (non-Canada) - 3-wire cord



3-wire receptacle
(NEMA type 10-30R)



WARNING

ELECTRICAL SHOCK HAZARD

Failure to disconnect power source before servicing could result in personal injury or even death.

Grounding the gas dryer (USA and Canada)



WARNING

Improper grounding of the laundry center may cause serious injury or death. Check with a licensed electrician if you are in doubt as to whether the appliance is properly grounded.

Grounding type wall receptacle

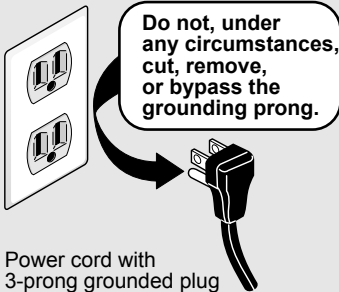

1. The laundry center is equipped with a three-prong (grounding) plug for your protection against shock hazard and should be plugged directly into a properly grounded three-prong receptacle.

1. Turn off power supply to outlet.
2. Remove the screw securing the terminal block access cover on the back of the dryer.
3. Install a UL-approved strain relief according to the power cord/strain relief manufacturer's instructions in the power cord entry hole below the access panel. At this time, the strain relief should be loosely in place.
4. Thread an UNPLUGGED, UL-approved, 30 amp. power cord, NEMA 10-30 type SRDT, through the strain relief.
5. Attach the power cord neutral (center wire) conductor to the SILVER colored center terminal on the terminal block. Tighten the screw securely.

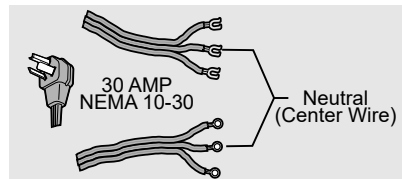

- Attach the remaining two power cord outer conductors to the outer, BRASS colored terminals on the terminal block. Tighten both screws securely.

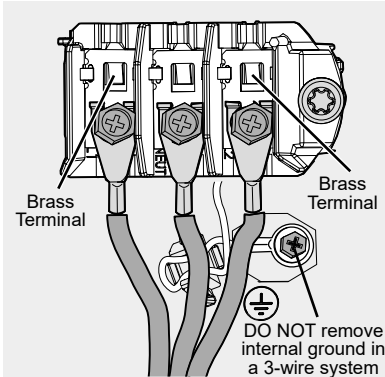

WARNING

ELECTRICAL SHOCK HAZARD

DO NOT make a sharp bend or crimp wiring/conductor at connections.

- Follow manufacturer's guidelines for firmly securing the strain relief and power cord.
- Reinstall the terminal block cover.



IMPORTANT

If moving dryer from a 4-wire system and installing it in a 3-wire system, move the internal ground from the center terminal back to the GREEN screw next to the terminal block.

Electrical connection (non-Canada) - 4-wire cord



4-wire receptacle (NEMA type 14-30R)



WARNING

ELECTRICAL SHOCK HAZARD

Failure to disconnect power source before servicing could result in personal injury or even death.

- Turn off wire supply to outlet.
- Remove the screw securing the terminal block access cover on the back of the dryer.
- Install a UL-approved strain relief according to the power cord/strain relief manufacturer's instructions in the power cord entry hole below the access panel. At this time, the strain relief should be loosely in place.
- Thread an UNPLUGGED, UL-approved, 30 amp, power cord, NEMA 14-30 type DRT or SRDT, through the strain relief.

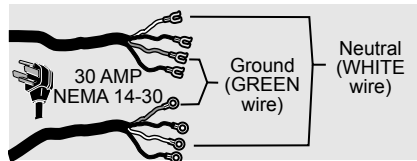

- Disconnect the internal (WHITE) dryer harness ground wire from the (GREEN) ground screw next to the terminal block.
- Attach the ground (GREEN) power cord wire to the cabinet with the ground (GREEN) screw. Tighten the screw securely.

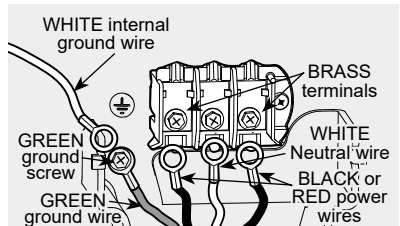

- Move the internal dryer harness ground (WHITE) wire to the terminal block and attach it along with the neutral (WHITE) power cord wire conductor to the center, SILVER colored terminal on the terminal block. Tighten the screw securely.

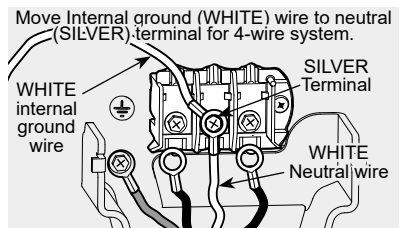

24 INSTALLATION

- Attach the RED and BLACK power cord conductors to the outer, BRASS colored terminals on the terminal block. Tighten both screws securely.

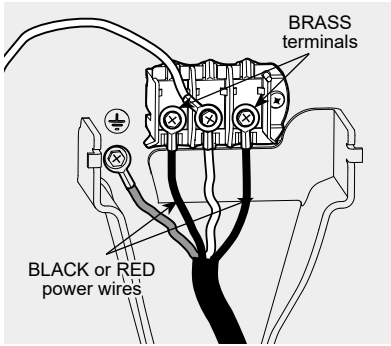

WARNING

ELECTRICAL SHOCK HAZARD

DO NOT make a sharp bend or crimp wiring/conductor at connections.

- Follow manufacturer's guidelines for firmly securing the strain relief and power cord.
- Reinstall the terminal block cover.

Leveling the laundry center

Excessive noise and vibration can be prevented by properly leveling the laundry center.

- With the laundry center within 4 feet (1 m) of its final location, place a level on top of the washer lid.

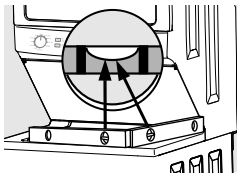

- Use adjustable pliers to adjust the leveling legs so the laundry center is level front-to-rear and side-to-side, and stable corner-to-corner.

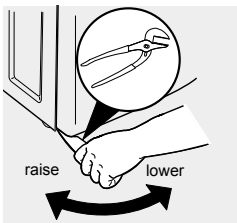

- Press down on alternate corners and sides and feel for the slightest movement.

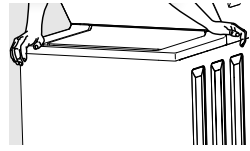

Adjust the appropriate leg(s) so the laundry center sits solidly on the floor on ALL four legs. Keep the leveling leg extension at a minimum for best performance of the washer.

Connecting the water

- Run some water from the hot and cold faucets to flush the water lines and remove particles that might clog the water valve screens and to determine which faucet is hot and which is cold supply.

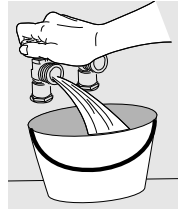

- Check to ensure that the inlet hoses have the rubber washer firmly in place. Use only new hoses.

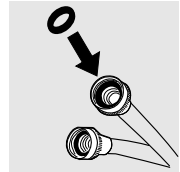

NOTE

Hoses are not included with laundry center purchase and must be purchased separately.

- Connect the HOT inlet hose to the HOT inlet connection on the washer and the COLD inlet hose to the COLD inlet connection on the washer (cold on top).

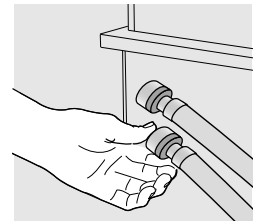

Tighten by hand until snug. Then tighten each supply connection another 2/3 turn with pliers. **DO NOT cross thread or over-tighten these connections.**

4. Connect the HOT inlet hose to the HOT water supply and the COLD inlet hose to the COLD water supply. Tighten by hand until snug.

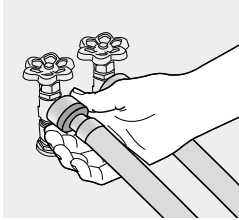

5. Tighten each supply connection another 2/3 turn with pliers. **DO NOT bend, kink, or pinch water inlet hoses.**

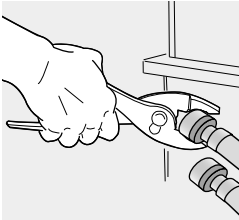

6. Turn on the water and check for leaks.

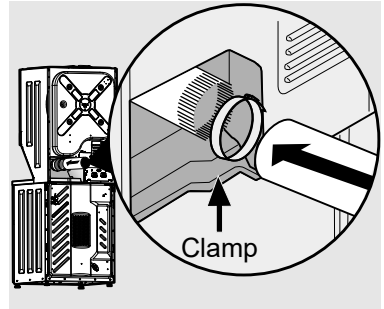

3. Reinstall the dryer front access panel.



WARNING

ELECTRIC SHOCK HAZARD

Certain internal parts are intentionally not grounded and may present a risk of electrical shock if contacted during installation. Do not contact the following parts while the appliance is energized:

- Pump
- Drive Motor
- Electronic control boards
- Water valve

4. Carefully slide the laundry center to its final position. Recheck for level and rock corners for stability.

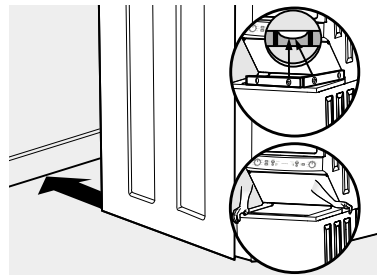

Connecting the exhaust

1. Remove the two screws securing the dryer front access panel to the dryer cabinet. Lift the panel until the tabs can be disengaged from the cabinet, remove the panel and set aside.

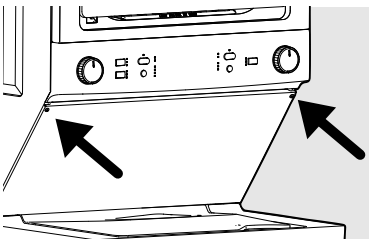

2. Connect the exhaust duct to the outside exhaust system. Use of a 4" (10.2 cm) clamp is recommended to connect the dryer to the exhaust vent system. Use metal foil tape to seal all other joints.

Connecting the drain

1. Form a "U" shape on the end of the drain hose with the hose pointed toward the drain.
2. Place the formed end in a laundry tub or a standpipe and secure the drain hose with the cable tie (provided in the enclosure package) to the standpipe, inlet hose, laundry tub, etc. so the hose does not pull out from the force of the water.

26 INSTALLATION

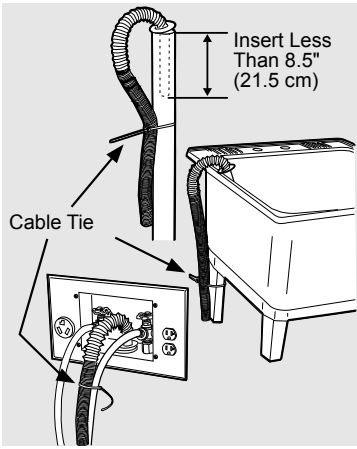

NOTE

The standpipe inside diameter must be 1-1/4" (3.2 cm) minimum. There must be an air gap around the drain hose in the standpipe. A snug hose fit can cause a siphoning action.

Completing the installation

IMPORTANT

Check to ensure the power is off at a circuit breaker/fuse box before plugging the power cord into an outlet.

1. Plug the power cord into a grounded outlet.

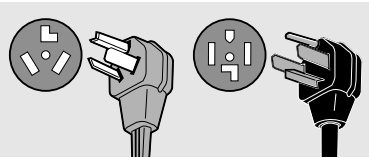

WARNING

Improper grounding of the dryer may cause serious injury or death. Check with a licensed electrician if you are in doubt as to whether the appliance is properly grounded.

Grounding type wall receptacle

Do not, under any circumstances, cut, remove, or bypass the grounding prong.

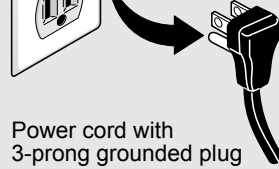

2. Turn on the power at the circuit breaker/fuse box.
3. Run the washer through a complete cycle, checking for water leaks and proper operation.
4. If you have any questions during initial operation, please review *Troubleshooting* before calling for service.
5. Place these instructions in a location near the appliance for future reference.

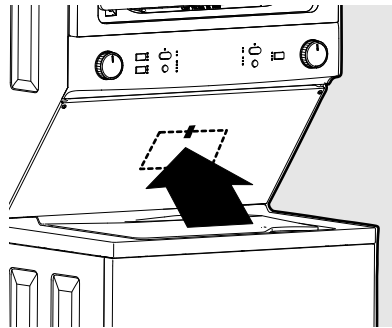

NOTE

A wiring diagram and technical data sheet are located behind the dryer access panel.

WARNING

When discarding or storing your old laundry center, ALWAYS remove the washer and dryer doors.

Accessories

LP CONVERSION KIT
P/N 5304523143

Gas dryers intended for use in a location supplied with LP must use a conversion kit prior to installation.

MOBILE HOME INSTALLATION KIT
P/N 137067200

Installation in a mobile home requires the use of a MOBILE HOME INSTALLATION KIT.

INLET HOSE KITS

Please call 866-233-8353 (in Canada, 800-265-8352) to explore hose kit options that will meet your specific installation needs.

TOUCH UP PAINT PENS*

Classic White Touch Up Pen -
P/N 5304468812

*Other colors may be available. Contact the source where you purchased your laundry center.

Replacement parts:

If replacements parts are needed for your laundry center, contact the source where you purchased your laundry center or refer to your Use and Care Guide for more information.



CAUTION

Failure to use accessories manufactured by (or approved by) the manufacturer could result in personal injury, property damage or damage to the washer.

Washer controls and settings

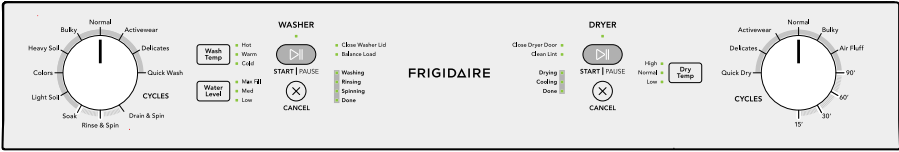

This manual covers many models and not all cycles, options, or features listed are available on every model. Consoles shown above for reference only. Your model may differ.

Wash cycle selection

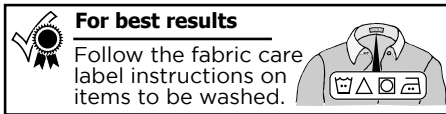

Turn the WASHER cycle selector in either direction to select a washing cycle.

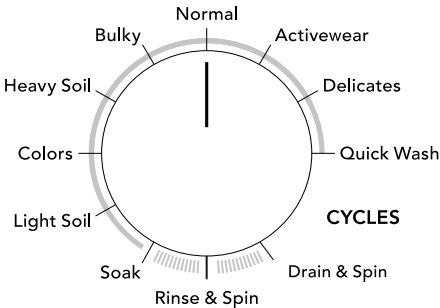

Normal

Select this cycle for normally soiled cottons, linens, towels, shirts, denims, and mixed loads.

Activewear

Select this cycle for small loads of light-weight, synthetic apparel worn for working out, running, swimming, cycling, tennis, and similar activities when removal of light soil and perspiration are important.

Delicates

Select this cycle for lightly soiled knits and delicates which require gentle washing.

Quick Wash

Select this cycle to quickly wash a small, lightly soiled load in 35 minutes.

Rinse & Spin

Select this cycle for loads that require a cold water rinse or to add fabric softener that may have been omitted in a regular cycle.

Drain & Spin

Select this cycle to drain excess water from a load.

Soak

Select this cycle to soak heavily soiled and stained items before washing. Cold water is recommended with this cycle as warmer water may set some stains. Use the amount of detergent recommended for a normal wash cycle. If desired, use a bleach or a soaking agent safe for the fabric. The washer will continue on with a soil-loosening wash cycle immediately after the soak phase.

Light Soil

Select this cycle for lightly soiled cottons, linens, towels, shirts, denims, and mixed loads.

Colors

Select this cycle for lightly soiled, dark, or highly dyed fabrics which may be susceptible to dye loss.

Heavy Soil

Select this cycle for heavily soiled cottons, linens, towels, shirts, denims, and mixed loads.

Bulky

Select this cycle for bulky items such as comforters, blankets, mattress pads, sleeping bags, and other similar items.



NOTE

Washers connected to water supplies with lower inlet pressure will experience longer filling times and may not complete cycle as quickly.

Wash cycle settings

Wash temp (water temperature)



Press the **Wash Temp** button to cycle through wash water temperatures until the desired temperature is selected. The LED will light to indicate the current selection. Select a wash water temperature according to fiber content, colorfastness, and soil level. To protect your fabrics, the temperature range of cold to hot settings may be different depending on cycle selected.

The water heater setting, its distance from the washer, water usage in other parts of the home, and seasonally low ground water temperature in some geographic areas can affect water temperature.

Hot

Select this setting for heavily soiled white or colorfast cottons and blends.

Warm

Select this setting for normally soiled white or colorfast cottons or blends.

Cold

Select this setting for lightly soiled non-colorfast items, knits, delicates, and hand washables. Some warm water will automatically blend with cold tap supply to achieve cold.

Water level



Press the **Water Level** button to cycle through wash water level until the desired water level is selected. The recommended water level can be determined by the size of the wash load.

MaxFill

Select the MaxFill water level setting if the tub is over one half (1/2) full.

Med (Medium)

Select the Medium water level setting if the tub is between one third (1/3) and one half (1/2) full.

Low

Select the Low setting if the tub is one third (1/3) or less full.

The **Medium** and **MaxFill** settings are also recommended for heavily soiled loads to remove excess dirt and detergent or if household members have sensitive skin.

Detergent Packs

For best results add the recommended quantity of detergent packs (One or Two) directly in the empty drum **BEFORE** placing the laundry into the unit.

DO NOT place the detergent packs on top of the laundry as the gel coating may stick to the clothes.

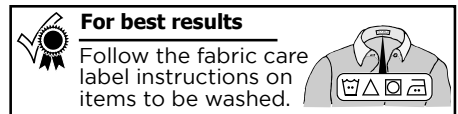

Washer setting chart

These temperatures and water levels are available with the following cycles

Quick Wash	Delicates	Activewear	Normal	Bulky	Heavy Soil	Colors	Light Soil	Soak	Rinse & Spin	*Drain & Spin
------------	-----------	------------	--------	-------	------------	--------	------------	------	--------------	---------------

Wash Temperature

Hot	✓		✓	✓	✓	✓	✓	✓	✓		
Warm	✓	✓	✓	✓	✓	✓	✓	✓	✓		
Cold	✓	✓	✓	✓	✓	✓	✓	✓	✓	✓	

Water Level

MaxFill	✓	✓	✓	✓	✓	✓	✓	✓	✓	✓	
Med	✓	✓	✓	✓	✓	✓	✓	✓	✓	✓	
Low	✓	✓	✓	✓	✓	✓	✓	✓	✓	✓	

✓ = Available selections. □ = Factory presets. ■ = Non-modifiable presets.

Wash cycle controls (Start, Pause, and Cancel)

START

Press WASHER

START|PAUSE button once to begin the wash cycle.

The unit will emit two short beeps, the LED will turn solid white, and the door lid lock will engage with an audible double click.

PAUSE

Press WASHER **START|PAUSE** button once while the washer is running to pause the wash cycle. The unit will emit one short beep, the LED will blink, the wash tub will come to a complete stop, and the

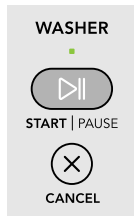

door lid safety lock will disengage with an audible double click. **The wash tub can take up to 6 minutes to stop after the START|PAUSE button is pressed. DO NOT force open the locked lid.** Press the **START|PAUSE** button again to restart the wash cycle.

CANCEL

Press WASHER **CANCEL** button to cancel the wash cycle. The unit will emit one long beep, the wash tub will come to a complete stop, and the door lid safety lock will disengage with an audible double click. **The wash tub can take up to 6 minutes to stop after the CANCEL button is pressed. DO NOT force open the locked lid.**

Wash cycle indicator lights

The washing cycle indicator lights provide information during the wash cycle.

The **Close Washer Lid** advisory LED will illuminate if the washer lid is open. Fully close the washer lid before starting the washer. The washer will not operate with the lid open.

The **Balance Load** advisory LED indicator will illuminate if the wash load is unbalanced in the drum during the wash cycle. Pause the washer and redistribute the wash load.

The **Cycle Status Lights** will illuminate as each stage of the wash cycle is reached.

Cycle Status Light stages include: **Washing, Rinsing, Spinning** and **Done**.

Chime

Press and hold the **Wash Temp** button for 3 seconds to mute or unmute the **chime** (on some models). Once muted, the sound from the button press and the end of cycle reminder will both be muted.

- Close Washer Lid
- Balance Load

- Washing
- Rinsing
- Spinning
- Done



WARNING

To reduce the risk of fire or serious injury to persons or property, comply with the basic warnings listed below:

- Read and comply with all instructions on stain removal products.
- Keep stain removal products in their original labeled containers and out of children's reach.
- DO NOT combine stain removal products, especially ammonia and chlorine bleach. Dangerous fumes can result.
- Never wash items which have been previously cleaned in, washed in, soaked in or spotted with gasoline, dry cleaning solvents or other flammable or explosive substances because they give off vapors that could ignite or explode.
- Never use highly flammable solvents, such as gasoline, inside the home. Vapors can explode on contact with flames or sparks.



WARNING

HARMFUL VAPOR HAZARD

DO NOT use or mix liquid chlorine bleach with other household chemicals such as toilet cleaners, rust removers, acid or products containing ammonia. These mixtures can produce dangerous fumes which can cause serious injury or death.



32 CONTROLS AND SETTINGS

Dryer controls and settings



This manual covers many models and not all cycles, options, or features listed are available on every model. Consoles shown above for reference only. Your model may differ.

Dry cycle selection

NOTE

The Clean Lint Filter LED will illuminate after each drying cycle as a reminder to clean the lint filter. The lint filter must be cleaned after every load. This is NOT a warning of a clogged exhaust duct or filter. Open door or press CANCEL to turn off the LED.



For best results

Follow the fabric care label instructions on items to be washed.

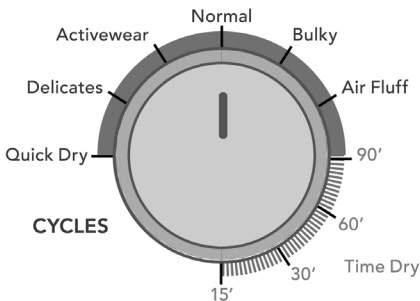

NOTE

To change settings after the cycle starts, press the **START | PAUSE** button and adjust the setting. Press the **START | PAUSE** button again to resume the cycle.

Auto dry cycles

Auto Dry cycles take the guesswork out of selecting the correct drying time for each load. With auto dry cycles, the load will automatically be dried at the selected temperature. When the load has neared the end of the drying cycle, it will continue to tumble for a brief cool down period. This helps reduce wrinkling and makes items easier to handle during unloading.

Drying time varies depending on size of load, dampness of load, and fabric type.

Available auto DRY settings are as follows:

Normal

Select this cycle to dry everyday fabrics including cottons, linens, and sheets.

Bulky

Select this cycle for bulky items such as comforters, blankets, mattress pads, sleeping bags, and other similar items.

Delicates

Select this cycle to dry cottons, blends, and permanent press items with a no-iron finish.

Activewear

Select this specialty cycle to dry lightweight synthetic athletic apparel including stretch fabrics.

Timed dry cycles



WARNING

FIRE HAZARD

To avoid fire hazard, DO NOT use heat to dry items containing feathers or down, foam rubber, plastics similarly textured, rubber-like materials. Use the **Air Fluff** setting.

Quick Dry

Select this timed cycle to quickly dry a small load made up of just a few items. It provides approximately 25 minutes of tumbling including a cool down period.

Timed dry

Select a timed drying cycle for any load using one of the preset cycles of **15, 30, 60,** or **90** minutes. The dryer will continue to heat throughout the cycle until the final cool down period.

Air Fluff

Select this cycle for loads that require air drying only. No heat is applied on this cycle. Use this setting for dry items such as items containing feathers, down, foam rubber, plastics, or rubber-like materials; to refresh clothing, stuffed animals, pillows, or blankets; and to dust draperies.

Drying cycle settings

Dry Temp (Drying Temperature)



Select the temperature setting most suitable for each load. To protect your fabrics, not all temperatures are available with every cycle. If an unavailable temperature setting is selected by the user, the nearest available temperature will be substituted.

High

Recommended for durable fabrics and towels.

Normal

Recommended for most cotton fabrics.

Low

Recommended for delicate fabrics.



NOTE

Air Fluff setting does not use heat and **WILL NOT** illuminate any of the Dry Temp LED lights.

34 CONTROLS AND SETTINGS

Drying cycle controls (Start, Pause, and Cancel)

START

Press DRYER

START|PAUSE button once to begin the drying cycle. The unit will emit one beep before the drum begins to rotate.

PAUSE

Press DRYER

START|PAUSE button while the dryer is running to pause the drying cycle. Opening the door with a cycle running will also pause the cycle. You will hear two beeps. **Allow the drum to come to a complete stop before reaching inside.** Press the DRYER **START|PAUSE** button while paused to restart the drying cycle.

CANCEL

Press the DRYER **CANCEL** button to cancel the drying cycle. Wait for the drum to come to a complete stop before reaching inside.

Chime

Press and hold the **DRY Temp** button for 3 seconds to mute or unmute the **chime** (on some models). Once muted, the sound from the button press and the end of cycle reminder will both be muted.

Dryer Setting Chart

These temperatures are available with the following cycles

	Quick Dry (25 min)	Delicates (Auto dry)	Activewear (Auto dry)	Normal (Auto dry)	Bulky (Auto dry)	Air Fluff - no heat(30 min)	90 min	60 min	30 min	15 min
--	-----------------------	-------------------------	--------------------------	----------------------	---------------------	--------------------------------	--------	--------	--------	--------

Dry Temp (Drying Temperature)

High	✓			✓	✓		✓	✓	✓	✓
Normal			✓	✓	✓		✓	✓	✓	✓
Low		✓	✓	✓	✓		✓	✓	✓	✓

✓ = Available selections. □ = Factory presets. ■ = Non-modifiable presets.

Drying cycle indicator lights

The drying cycle indicator lights provide information during the dry cycle.

The **Close Dryer**

Door advisory LED will illuminate if the dryer door is open. Fully close the dryer door before starting the dryer. The dryer will not operate with the door open.

Close Dryer Door ■

Clean Lint Filter ■

Drying ■

Cooling ■

Done ■

NOTE

The Clean Lint Filter LED will illuminate after each drying cycle as a reminder to clean the lint filter. The lint filter must be cleaned after every load. This is NOT a warning of a clogged exhaust duct or filter. Open door or press CANCEL to turn off the LED.

The **cycle status lights** will illuminate as each stage of the drying cycle is reached. Stages include: **Drying**, **Cooling**, and **Done**.

Operating the washer

! WARNING

To reduce the risk of fire, electric shock or injury to persons, read the Important Safety Information in this *Use & Care Guide* before operating your washer.

! WARNING

DO NOT wash water-resistant and water-repellent type clothing or other materials. Failure to closely follow these instructions may result in abnormal vibrating and out-of-balance conditions that could result in physical injury, property damage, and/or appliance damage.



! CAUTION

To avoid serious personal injury, DO NOT operate washer if safety lid lock is missing, damaged or operating improperly.

📌 NOTE

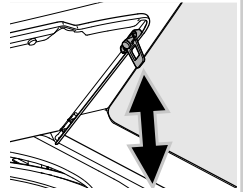

To prevent injury, the lid will remain locked for up to 6 minutes after the cycle ends, to allow the wash tub to stop spinning.



STEPS	TIPS	IMPORTANT
<p>1. Sort laundry into loads that can be washed together.</p> 	<ul style="list-style-type: none"> Sort by recommended cycle and water temperature. Separate white, light, and colorfast items from dark and non-colorfast items. Separate items that shed lint from items that attract lint. Casual, synthetic, knit, and corduroy items will pick up lint from towels, rugs, and bedspreads. Separate heavily soiled items from lightly soiled items. Separate lacy, sheer, loosely knit, or delicate items from durable items. 	<ul style="list-style-type: none"> DO NOT machine wash items containing fiberglass. Small particles of fiberglass left in drum may transfer to fabrics in other loads and cause skin irritation and/or damage to fabrics. DO NOT wash water-resistant and water-repellent type clothing or other materials.
<p>2. Prepare items for washing.</p> 	<ul style="list-style-type: none"> Empty pockets. Brush off lint and dirt. Shake out rugs and beach towels. Close zippers, fasten hooks, button buttons, and tie strings/sashes. Remove non-washable trims and ornaments. Place delicate and small items such as bras and hosiery in a mesh bag (not included). 	<ul style="list-style-type: none"> Mend rips and tears to prevent further damage during washing. Turn knit items inside out to prevent pilling.
<p>3. Pretreat stains and heavy soil.</p>	<ul style="list-style-type: none"> See <i>Stain Removal Guide</i> for safe, successful stain removal instructions. 	

36

OPERATING INSTRUCTIONS

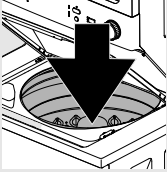
STEPS	TIPS	IMPORTANT
4. Add liquid detergent/ detergent packs or powder detergent to wash tub BEFORE adding load.	<ul style="list-style-type: none">• The amount of detergent required depends on the type of detergent, load size, and water hardness.• Add the packs directly in the empty drum BEFORE placing the laundry into the unit. Do not add more detergent packs than recommended as this can result in residual detergent being leftover at the end of the cycle.	<ul style="list-style-type: none">• For best results add the recommended quantity of detergent packs (One or Two) directly in the empty drum BEFORE placing the laundry into the unit.• DO NOT place the detergent packs on top of the laundry as the gel coating may stick to the clothes.• Follow manufacturer's instructions for recommended amount of detergent.• Use a low-sudsing, high-efficiency detergent to prevent oversudsing.• Look for the  high-efficiency symbol on the detergent label.
5. Add other wash products to wash tub (if desired).	<ul style="list-style-type: none">• Water conditioners, detergent boosters, and enzyme products may be added with detergent.	<ul style="list-style-type: none">• See product manufacturer's instructions.
6. Add bleach (if desired) before adding load. 	<ul style="list-style-type: none">• If using liquid bleach, add to bleach dispenser located in left front corner under lid. Then add 1 cup (240 ml) water to flush dispenser.• If using powdered bleach, add directly to the empty tub.	<ul style="list-style-type: none">• Follow manufacturer's instructions for recommended amount of bleach.• DO NOT use powdered bleach in bleach dispenser.
7. Add laundry load to wash tub. 	<ul style="list-style-type: none">• Add items one at a time, each tightly bunched into its own "ball" to allow beneficial item interaction. Avoid loading items in a flat, laid-out fashion.• For best washing performance, dry load level should not be higher than the upper row of holes in the wash tub.• Combine large and small items in a load. Load small items first. Large items should not be more than half the total wash load.• When washing a single heavy item, add 1 or 2 towels to balance the load.	<ul style="list-style-type: none">• DO NOT overload the washer.

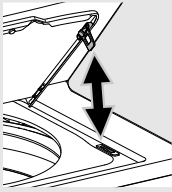
STEPS	TIPS	IMPORTANT
<p>8. Add liquid fabric softener to the final rinse (if desired).</p>	<ul style="list-style-type: none"> • Add diluted fabric softener to the final rinse following fabric softener manufacturer's instructions. • A fabric softener dispensing ball can also be used. 	<ul style="list-style-type: none"> • To prevent staining, do not pour liquid fabric softener directly on to wash load.
<p>9. Select washing cycle and settings for each load.</p>	<ul style="list-style-type: none"> • See <i>Washer Cycle Selection</i> and <i>Washer Cycle Settings</i> on the following pages. • Unit will emit three short beeps to indicate it is in "wake" mode and ready to operate. 	<ul style="list-style-type: none"> • For best results, follow fabric care label on items to be washed.
<p>10. Close the washer lid and start the washer.</p>	<ul style="list-style-type: none"> • See <i>Washing Cycle Controls (Start, Pause, and Cancel)</i> on the following pages. • LED will light solid when washer is running. 	<ul style="list-style-type: none"> • Pausing a wash cycle while washer is running may affect performance of the wash cycle.
<p>11. Remove items when the cycle is completed.</p> 	<ul style="list-style-type: none"> • For your safety, the lid is locked during the operation of the washer. • Once cycle has ended, wash tub will come to a complete stop and door lid safety lock will disengage with an audible double click. • Place washed items in automatic dryer, line dry, or dry flat as directed by fabric care label. Excess wrinkling, color transfer or odors may develop in items left in the washer after the cycle has ended. 	<ul style="list-style-type: none"> • DO NOT force open the locked lid. • For safety, the lid will remain locked for up to 6 minutes. • For best results, follow fabric care label on items to be dried.

Operating the dryer



WARNING

To reduce the risk of fire, electric shock or injury to persons, read the Important Safety Information in this *Use & Care Guide* before operating your dryer.



CAUTION

- DO NOT operate dryer without lint filter in place.
- ALWAYS clean filter after each load.

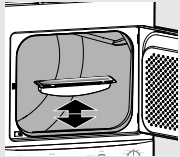
STEPS	TIPS	IMPORTANT
<p>1. Prepare load for drying.</p>	<ul style="list-style-type: none"> • Dry items of similar fabric, weight, and construction in the same load. • Separate dark items from light-colored items. Separate items that shed lint from those that attract lint. • Check for stains which may not have been removed in washing. Repeat stain removal process and wash again before drying. • Place delicate or small items in a mesh bag (not included). • Be sure buckles, buttons, and trim are heatproof and won't damage the drum finish. Close zippers, buttons, hooks, and hook and loop fasteners. Tie strings and sashes to prevent snagging and tangling. 	<ul style="list-style-type: none"> • Dryer heat may permanently set some stains.
<p>2. Check that the lint filter is clean and in place.</p>		<ul style="list-style-type: none"> • DO NOT operate dryer without lint filter in place. • DO NOT operate dryer without cleaning the filter before use.
<p>3. Load the dryer and close the door.</p>	<ul style="list-style-type: none"> • Load items loosely. The average wet load will fill the drum 1/3 to 1/2 full. Items need room to tumble freely for even drying and less wrinkling. • If desired, place a dryer fabric softener sheet on top of the load at the beginning of the cycle. • When drying large items, dry only two or three items at a time. Fill out the load with smaller items. • For delicate or very small loads, add two or three similar items to improve tumbling action. 	<ul style="list-style-type: none"> • DO NOT overload the dryer.

STEPS	TIPS	IMPORTANT
4. Select the cycle and settings for each load.	<ul style="list-style-type: none">• See <i>Drying Cycle Selection</i> and <i>Drying Cycle Settings</i> on the following pages.• Over-drying can cause wrinkles, shrinkage, lint, harshness, and build up of static electricity.	<ul style="list-style-type: none">• For best results, follow fabric care label on items to be dried.
5. Start the dryer.	<ul style="list-style-type: none">• If drying a single large or bulky item, such as a comforter, remove the item part way through the cycle and turn it “inside out” to maximize drying effectiveness. Place item back in dryer and re-start cycle.• See <i>Drying Cycle Controls (Start, Pause, and Cancel)</i> on the following pages.	<ul style="list-style-type: none">• <i>The dryer WILL NOT operate with the door open.</i>
6. Remove items when cycle completes.	<ul style="list-style-type: none">• Immediately hang or fold when the load is completed.	<ul style="list-style-type: none">• Always clean filter after each use.

40 STAIN REMOVAL GUIDE

Safe stain removal procedures

- Remove stains promptly.
- Follow the recommended treatment in the stain removal chart on the next page.
- To pretreat stains, use a prewash product, liquid detergent, or a paste made from powder detergent and water.
- Use cold water on unknown stains as hot water can set stains.
- Consult care label instructions for treatments to avoid on specific fabrics.
- Check for colorfastness by testing stain remover products on an inside seam.
- Rinse and wash items after stain removal.



WARNING

Never use highly flammable solvents, such as gasoline, inside the home. Vapors can explode on contact with flames or sparks.



WARNING

HARMFUL VAPOR HAZARD

DO NOT use or mix liquid chlorine bleach with other household chemicals such as toilet cleaners, rust removers, acids such as vinegar, or products containing ammonia. These mixtures can produce dangerous fumes which can cause serious injury or death.



WARNING

To reduce the risk of fire or serious injury to persons or property, comply with the basic warnings listed below:

- Read and comply with all instructions on stain removal products.
- Keep stain removal products in their original labeled containers and out of children's reach.
- DO NOT combine stain removal products, especially ammonia and chlorine bleach. Dangerous fumes can result.
- Never wash items which have been previously cleaned in, washed in, soaked in or spotted with gasoline, dry cleaning solvents or other flammable or explosive substances because they give off vapors that could ignite or explode.



Stain Removal Suggestions

STAIN	TREATMENT
Adhesive tape, rubber cement, gum	Apply ice. Scrape off excess. Place stain face down on paper towels. Saturate with prewash stain remover or nonflammable dry cleaning fluid.
Baby formula, dairy products, egg	Use product containing enzymes to pretreat or soak stains. Soak for 30 minutes or more. Wash.
Beverages (coffee, alcoholic beverages, tea, soda, juice)	Pretreat stain. Wash using cold water and bleach safe for fabric.
Blood	Rinse with cold water. Rub with bar soap. Or, pretreat or soak with product containing enzymes. Wash using bleach safe for fabric.
Candle wax, crayon	Scrape off surface wax. Place stain face down between paper towels. Press with warm iron until wax is absorbed. Replace paper towels frequently. Treat remaining stain with prewash stain remover or nonflammable dry cleaning fluid. Hand wash to remove solvent. Wash using bleach safe for fabric.
Chocolate	Pretreat or soak in warm water using product containing enzymes. Wash using bleach safe for fabric.
Collar or cuff soil, cosmetics	Pretreat with prewash stain remover or rub with bar soap.
Dye transfer on white fabric	Use packaged color remover. Wash using bleach safe for fabric.
Grass	Pretreat or soak in warm water using product containing enzymes. Wash using bleach safe for fabric.
Grease, oil, tar (butter, fats, cooking oils, car grease, motor oils)	Scrape residue from fabric. Pretreat. Wash using hottest water safe for fabric. For heavy stains and tar, apply nonflammable dry cleaning fluid to back of stain. Replace towels under stain frequently. Rinse thoroughly. Wash using hottest water safe for fabric.
Ink	Some inks may be impossible to remove. Washing may set some inks. Use prewash stain remover, denatured alcohol or nonflammable dry cleaning fluid.
Mildew, scorch	Wash with chlorine bleach if safe for fabric. Or, soak in oxygen bleach and hot water before washing. Badly mildewed fabrics may be permanently damaged.
Mud	Brush off dry mud. Pretreat or soak with product containing enzymes.
Mustard, tomato	Pretreat with prewash stain remover. Wash using bleach safe for fabric.
Nail polish	May be impossible to remove. Place stain face down on paper towels. Apply nail polish remover to back of stain. Repeat, replacing paper towels frequently. DO NOT use on acetate fabrics.
Paint, varnish	WATER-BASED: Rinse fabric in cool water while stain is wet. Wash. Once paint is dry, it cannot be removed. OIL-BASED AND VARNISH: Use solvent recommended on can label. Rinse thoroughly before washing.
Perspiration	Use prewash stain remover or rub with bar soap. Rinse. Wash using non-chlorine bleach in hottest water safe for fabric.
Rust, brown or yellow discoloration	Use rust remover safe for fabric. DO NOT use chlorine bleach because it may intensify discoloration.
Shoe polish	LIQUID: Pretreat with a paste of powder detergent and water. PASTE: Scrape residue from fabric. Pretreat with prewash stain remover or nonflammable dry cleaning fluid. Rinse. Rub detergent into dampened area. Wash using bleach safe for fabric.
Tomato	Pretreat with prewash stain remover. Wash using bleach safe for fabric.
Urine, vomit, mucus, feces	Pretreat or soak in product containing enzymes. Wash using bleach safe for fabric.
Wine	Pretreat or soak in cold water. Wash in hot water using bleach safe for fabric.

42 CARE AND CLEANING



WARNING

FIRE HAZARD

A clothes dryer produces combustible lint. The dryer must be connected to an outdoors exhaust. Regularly inspect the outdoor exhaust opening and remove any accumulation of lint around the opening and in the surrounding area.



IMPORTANT

Clean the lint filter after every load.



WARNING

To reduce risk of fire or serious injury to persons or property, comply with the basic warnings listed in the Important Safety Information and in this *Care and Cleaning* section.



WARNING

FIRE HAZARD / HARMFUL VAPOR HAZARD

Before cleaning the laundry center interior, unplug the electrical power cord to avoid electrical shock hazards.

Cleaning Inside of Dryer



WARNING

FIRE HAZARD / HARMFUL VAPOR HAZARD

DO NOT use any type spray cleanser when cleaning the dryer interior. Hazardous fumes or electrical shock could occur.

- Clean the lint filter after every load. Lint build-up on the filter restricts air flow, which causes longer drying times. The filter is located in the dryer door. Remove by pulling straight up. Remove the lint and replace the filter.
- Occasionally a waxy build-up may form on the lint filter from using dryer-added fabric softener sheets. To remove this build-up, wash the filter with warm, soapy water. Dry the filter thoroughly and replace. DO NOT operate the dryer without the lint filter in place.
- If the dryer drum becomes stained from non colorfast fabrics, clean the drum with a damp cloth and a mild liquid household cleanser. Remove cleanser residue before drying the next load.
- **Every 18 months a qualified service personnel should clean the dryer cabinet interior and exhaust duct. These areas can collect lint and dust over time. An excessive amount of lint build-up could result in inefficient drying and possible fire hazard.**

Cleaning Inside of Washer

- Remove items from the washer as soon as the cycle ends. Excess wrinkling, color transfer, and odors may develop in items left in the washer.
 - Dry the washer top, the area around the lid opening, and the underside of the lid. These areas should always be dry before the lid is closed.
 - Before cleaning the washer interior, unplug the electrical power cord to avoid electrical shock hazards.
 - When extremely soiled items have been washed, a dirty residue may remain on the tub. Remove this by wiping the tub with a nonabrasive household cleanser. Rinse thoroughly with water.
-

- The base plate or tub may become stained from fabric dye. Clean these parts with a nonabrasive household cleanser. This prevents dye transfer to future loads.

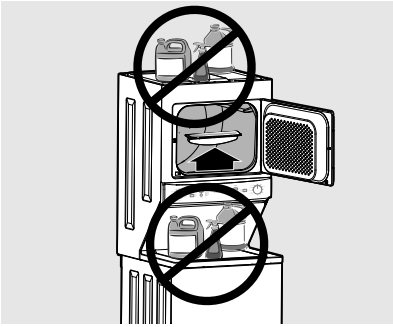
**IMPORTANT**

DO NOT store or place laundry products on top of laundry center at any time. They can damage the finish or controls.

Cleaning Outside of Laundry Center

- When washing is completed, wipe top and sides of laundry center with a damp cloth. Turn water faucets off to prevent pressure build-up in the hoses.
- Clean the cabinet with mild soap and water. Never use harsh, gritty or abrasive cleansers.
- If the cabinet becomes stained, clean with diluted chlorine bleach (1 part bleach to 8 parts water). Rinse several times with clear water.
- When cleaning chrome parts, it is best to use only a damp cloth.
- Remove glue residue from tape or labels with a mixture of warm water and mild detergent. Or, touch residue with the sticky side of tape.
- Before moving the laundry center, place a strip of cardboard or thin fiberboard under the front leveling legs to prevent damage to the floor.

44 CARE AND CLEANING

Winterizing Instructions



IMPORTANT

Winterize the laundry center if it is stored in an area where freezing can occur or moved in freezing temperatures to prevent damage to the washer:

1. Turn off water supply faucets.
2. Disconnect hoses from water supply and drain water from hoses.
3. Plug electrical cord into a properly grounded electrical outlet.
4. Add 1 gallon (3.8 L) nontoxic recreational vehicle (RV) antifreeze to empty wash drum. Close door.
5. Select the rinse & spin cycle. Start the cycle and let the washer drain for 1 minute to drain out all the water. Not all of the RV antifreeze will be expelled.
6. Stop the cycle, unplug electrical power cord, dry off tub interior, and close the lid.
7. Store laundry center in an upright position.
8. To remove antifreeze from washer after storage, run empty washer through a complete cycle using detergent. DO NOT add wash load.



Water inlet hose inspection

Periodically inspect all water inlet hoses for water leaks, wear, cuts, corrosion and bulges. Replace all hoses, if any sign of the above is visible. All hoses should be replaced every 5 years to reduce the risk of hose failures. When replacing hoses, refer to the Installation sections of this Use & Care guide for proper installation instructions. DO NOT overtighten or cross thread the fittings. DO NOT allow the hose to rub against sharp objects. Always ensure the hose fitting rubber gasket is installed and free from water leaks when water pressure is applied.

Common washing inquiries

Many washing problems involve poor soil and stain removal, residues of lint and scum, and fabric damage. For satisfactory washing results, follow these suggestions provided by The Soap and Detergent Association.

PROBLEM	POSSIBLE CAUSES	SOLUTIONS	PREVENTIVE MEASURES
Blue stains	<ul style="list-style-type: none"> • Undiluted liquid detergent or fabric softener dispensed directly onto fabric. 	<ul style="list-style-type: none"> • If caused by detergent, mix 1 cup (240 ml) white vinegar with 1 quart (.95 L) water in a plastic container. Soak item for 1 hour, then rinse. • If caused by fabric softener, rub with bar soap and rewash. 	<ul style="list-style-type: none"> • Add detergent to empty tub. DO NOT pour on dry load. • Avoid overfilling fabric softener compartment of dispenser.
Discoloration, graying	<ul style="list-style-type: none"> • Not enough detergent. • Wash water temperature too low. • Incorrect sorting. 	<ul style="list-style-type: none"> • Rewash with correct amount of detergent and hottest water safe for fabric. • Add bleach safe for fabric. 	<ul style="list-style-type: none"> • Sort items by soil level and color. • Use correct amount of detergent, hottest water, and bleach safe for fabric.
Greasy, oily stains	<ul style="list-style-type: none"> • Not enough detergent. • Undiluted liquid fabric softener poured directly on fabric. 	<ul style="list-style-type: none"> • Treat with prewash stain remover or liquid detergent. • Increase detergent and water temperature, and rewash. • Rub fabric softener stains with bar soap and rewash. 	<ul style="list-style-type: none"> • Use correct amount of detergent and hottest water safe for fabric. • DO NOT pour liquid fabric softener directly on fabric. See <i>Operating Instructions</i>.
Holes, tears, or snags	<ul style="list-style-type: none"> • Incorrect use of chlorine bleach. • Unfastened zippers, hooks, and buckles. • Rips, tears, and broken threads. • Overloading the washer. • Degradation of fabric. 	<ul style="list-style-type: none"> • May be irreversible if rips, tears, and seams cannot be mended. 	<ul style="list-style-type: none"> • DO NOT pour chlorine bleach directly on fabric. • Check condition of items before washing. See <i>Operating Instructions</i>.
Lint	<ul style="list-style-type: none"> • Incorrect sorting. • Tissues left in pocket. • Overloading the washer. • Not enough detergent. • Undissolved detergent has left residue resembling lint. • Static cling is attracting lint. • Load washed too long. 	<ul style="list-style-type: none"> • Reduce load size. Rewash using correct water temperature, water level, and amount of detergent. • Add non precipitating water conditioner to wash water to remove detergent residue. • Add fabric softener to final rinse. • Dry load in dryer. • Remove lint with lint brush or roller. 	<ul style="list-style-type: none"> • See <i>Operating Instructions</i>, steps. • DO NOT overload washer. • Use correct temperature, amount of detergent, water, and wash time.

46 TROUBLESHOOTING

Common washing inquiries (continued)

PROBLEM	POSSIBLE CAUSES	SOLUTIONS	PREVENTIVE MEASURES
Pilling (Fibers ball up and cling to fabric)	<ul style="list-style-type: none"> Pilling is normal with synthetic and permanent press fabrics due to abrasion from normal wear. 	<ul style="list-style-type: none"> Use a lint brush or shaver to remove pills. 	<ul style="list-style-type: none"> Use fabric softener in washer to lubricate fibers. When ironing, use spray starch or fabric finish on collars and cuffs. Turn items inside out to reduce abrasion.
Residue or powder on dark items; Stiff, harsh fabrics	<ul style="list-style-type: none"> Undissolved detergent. Some granular detergents can combine with hard water minerals to form a residue. Overloading the washer. 	<ul style="list-style-type: none"> Rewash load. 	<ul style="list-style-type: none"> Increase water temperature using hottest water safe for fabric. DO NOT overload washer. Use liquid detergent or use non precipitating water conditioner with powder detergent.
Unexpected washing results of large items	<ul style="list-style-type: none"> Poor movement of large items during wash action. Large items loaded incorrectly in a flat fashion. 	<ul style="list-style-type: none"> Rearrange load and rewash. 	<ul style="list-style-type: none"> Add items one at a time, each tightly bunched into its own ball, to allow beneficial item interaction. Avoid loading items in a flat, laid-out fashion.
Wrinkling	<ul style="list-style-type: none"> Overloading the washer. Incorrect wash cycle for wash load. 	<ul style="list-style-type: none"> Reduce load size. Rinse in cold water with liquid fabric softener using the casual or delicate cycle. 	<ul style="list-style-type: none"> DO NOT overload washer. Remove items from washer as soon as cycle is completed. Use liquid fabric softener.
Yellow buildup of body soil on synthetic fabrics	<ul style="list-style-type: none"> Agitation time too short. Water temperature too low. Not enough detergent. 	<ul style="list-style-type: none"> Soak in detergent booster or product containing enzymes. Wash in hottest water safe for fabric using casual cycle. Increase detergent. Add bleach safe for fabric or treat with color remover. 	<ul style="list-style-type: none"> Select correct wash cycle. Use correct amount of detergent. Wash synthetics frequently using hot or warm water.
Yellow or brown rust stains	<ul style="list-style-type: none"> Iron or manganese in water supply, water pipes, or water heater. 	<ul style="list-style-type: none"> To restore discolored load of whites, use rust remover safe for fabric. DO NOT use chlorine bleach to remove rust stains. It may intensify discoloration. 	<ul style="list-style-type: none"> Use non precipitating water softener. Before washing, run hot water for a few minutes to clear lines. Drain water heater occasionally. For an ongoing problem, install iron filter in your water supply system.

Common drying inquiries

Many drying problems involve poor drying results, excess lint and residues of lint and scum, and fabric damage. For satisfactory drying results, follow these suggestions provided by The Soap and Detergent Association.

PROBLEM	POSSIBLE CAUSES	SOLUTIONS	PREVENTIVE MEASURES
Greasy, oily stains	<ul style="list-style-type: none"> • Use of fabric softener sheet. 	<ul style="list-style-type: none"> • Rub fabric softener stains with bar soap. Rinse and rewash. 	<ul style="list-style-type: none"> • Add a few bath towels to small loads for proper tumbling. • Some silk-like fabrics should be air dried. • Use proper drying temperature. • Place fabric softener sheet in load before starting the dryer.
Lint	<ul style="list-style-type: none"> • Overloading the dryer. • Overdrying causes static electricity. • Lint filter not clean when cycle began. • Lint attached to pills. 	<ul style="list-style-type: none"> • Reduce load size and rewash using liquid fabric softener in the final rinse. • Add a fabric softener sheet and tumble with no heat. • Use lint brush or roller to remove lint. 	<ul style="list-style-type: none"> • DO NOT overload dryer. • Use fabric softener in washer or dryer to reduce static electricity. • Remove items when slightly damp to avoid overdrying. • Check that lint filter is clean and in place.
Pilling (Fibers break off, ball up and cling to fabric)	<ul style="list-style-type: none"> • Overdrying. 	<ul style="list-style-type: none"> • Use a lint brush or shaver to remove pills. 	<ul style="list-style-type: none"> • Use fabric softener to lubricate fibers. • If ironing, use spray starch or fabric finish on collars and cuffs. • Turn items inside out to reduce abrasion.
Shrinking	<ul style="list-style-type: none"> • Temperature too high. • Overdrying. 	<ul style="list-style-type: none"> • Irreversible condition. 	<ul style="list-style-type: none"> • Follow fabric care label directions. • If shrinking is a concern, check load often. • Remove items while slightly damp and hang or lay flat to complete drying. • Block knits into shape.
Wrinkling	<ul style="list-style-type: none"> • Overloading the dryer. • Leaving items in dryer after cycle ends. 	<ul style="list-style-type: none"> • Reduce load size and tumble at medium or low heat for 5-10 min. • Remove items immediately. Hang or fold. 	<ul style="list-style-type: none"> • DO NOT overload dryer. • Remove items as soon as cycle ends.

Before Calling

Before calling for service, review this list. It may save both time and expense. The list includes common occurrences that are not the result of defective workmanship or materials in this laundry center.

PROBLEM	POSSIBLE CAUSES	SOLUTIONS
NOISE		
Rattling and clanking noise	<ul style="list-style-type: none"> Foreign objects such as coins or safety pins may be in drum or pump. Belt buckles and metal fasteners are hitting wash drum. 	<ul style="list-style-type: none"> Stop washer and check drum. If noise continues after washer is restarted, objects may be in pump. Call your authorized service provider. To prevent unnecessary noise and damage to tub, fasten fasteners and turn items inside out.
Thumping sound	<ul style="list-style-type: none"> Heavy wash loads may produce a thumping sound. This is usually normal. If sound continues, washer may be out of balance. 	<ul style="list-style-type: none"> Stop washer and redistribute wash load.
Vibrating noise	<ul style="list-style-type: none"> Washer is not resting firmly on floor. Wash load unevenly distributed in tub. 	<ul style="list-style-type: none"> Move washer so it rests firmly on floor. Adjust leveling legs. See <i>Installation</i> section for details. Stop washer and rearrange wash load.
OPERATING		
Washer does not start	<ul style="list-style-type: none"> Washer lid is open. Electrical power cord may not be plugged in or connection may be loose. House fuse blown, circuit breaker tripped, or a power outage has occurred. Water supply is not turned on. Motor is overheated. Washer motor will stop if it becomes overheated. 	<ul style="list-style-type: none"> Close washer lid. Washer will not operate when the lid is open. Make sure plug fits tightly in wall outlet. Reset circuit breaker or replace fuse. DO NOT increase fuse capacity. If problem is a circuit overload, have it corrected by a qualified electrician. If problem is a power outage, call local electric company. Turn on water supply faucets. Wait for the motor to cool down before attempting to restart.
Washer won't spin	<ul style="list-style-type: none"> Lid is not completely closed. 	<ul style="list-style-type: none"> Close washer lid. The washer will not operate when the lid is open.
Residue left in drum	<ul style="list-style-type: none"> Heavily soiled items. 	<ul style="list-style-type: none"> Wipe drum with a nonabrasive household cleanser, then rinse. Shake or brush excess dirt and sand from items before washing.
Dryer does not start	<ul style="list-style-type: none"> Electrical power cord is not securely plugged in or plug may be loose. House fuse blown or circuit breaker tripped. Thermal limiter tripped. 	<ul style="list-style-type: none"> Make sure the plug fits tightly in wall outlet. Reset circuit breaker or replace fuse. Make sure electrical line is not overloaded. Call authorized service person for replacement.

Before Calling (continued)

PROBLEM	POSSIBLE CAUSES	SOLUTIONS
No sound from button press or end of cycle notification	<ul style="list-style-type: none"> The chime feature has been muted 	<ul style="list-style-type: none"> Press and hold the Wash Temp button for 3 seconds to unmute the chime (on some models). Once unmuted, the sound from the button press and end of cycle reminder will both be restored.
Dryer runs but won't heat	<ul style="list-style-type: none"> If 1 of the 2 fuses in the dryer circuit is blown, the drum may turn but the heater will not operate (electric models). Gas supply valve is not open (gas models). Dryer does not have enough air supply to support the burner flame (gas models). LP gas supply tank is empty or there has been a utility interruption of natural gas (gas models). 	<ul style="list-style-type: none"> Replace fuse. Check to make sure supply valve is open. See <i>Installation</i> section for procedure. See <i>Installation</i> section. Refill or replace tank. Dryer should heat when utility service is restored.
<p>Drying cycle takes too long</p> <p>Outside of the dryer feels too hot or smells hot</p>	<ul style="list-style-type: none"> Lint filter is clogged with lint. Exhaust duct requirements have not been met. Electric dryer is connected to a 208 volt circuit. Drying procedures not followed. Outside exhaust hood or exhaust duct may be clogged or restricted. High humidity. 	<ul style="list-style-type: none"> Make sure all lint has been removed from the dryer lint filter before starting each cycle. Exhaust duct must be at least 4 inches in diameter and made of rigid or semi-rigid metal. When in place, the duct must have no more than three 90° bends and must not exceed length listed in <i>Installation</i> section. Drying time will be 20% longer when drying on a 208 volt circuit than when drying on a 240 volt circuit. See Operating Instructions. Clean out any obstruction. Use a dehumidifier near the dryer.

PROBLEM	POSSIBLE CAUSES	SOLUTIONS
Excessive wrinkling	<ul style="list-style-type: none"> • Dryer is overloaded. • Items left in dryer too long. • Insufficient sorting of items. • Drying temperature too high. 	<ul style="list-style-type: none"> • DO NOT overload. See Operating Instructions. • Remove items as soon as cycle ends. • See Operating Instructions. • Follow fabric care label instructions.
Scratching or chipping of the drum finish	<ul style="list-style-type: none"> • Foreign objects such as coins, pins, clips or buttons are inside the dryer.* • Permanently attached items such as belt buckles, zippers, and fasteners may be hitting the inside of the drum.* 	<ul style="list-style-type: none"> • Always remove foreign objects from pockets before laundering. Remove objects from drum and restart dryer. • Turn items inside out before drying to prevent scratching and damage to the dryer.
<p>*Drum damage caused by foreign objects or permanently attached items is not covered by the warranty.</p>		
WATER		
Wash load too wet after spin	<ul style="list-style-type: none"> • Washer is overloaded. • Load is out of balance. • Drain hose is kinked. 	<ul style="list-style-type: none"> • DO NOT overload washer. See Operating Instructions. • Rearrange load to allow proper spinning. • Straighten drain hose.

Before Calling (continued)

PROBLEM	POSSIBLE CAUSES	SOLUTIONS
Water does not enter washer or it enters slowly	<ul style="list-style-type: none"> • Washer lid is open. • Water supply is not adequate in area. • Water supply faucets are not completely open. • Water is being used elsewhere in the house. • Water inlet hoses are kinked. 	<ul style="list-style-type: none"> • Close washer lid. The washer will not operate when the lid is open. • Check another faucet in the house. Wait until water supply and pressure increase. • Fully open hot and cold faucets. • Water pressure must be at least 10 psi (69 kPa). Avoid running water elsewhere while washer is filling. • Straighten hoses.
Warm or hot water is not hot enough	<ul style="list-style-type: none"> • Hot water heater is set too low or is a distance from washer. • Hot water is being used elsewhere in the house. 	<ul style="list-style-type: none"> • Measure hot water temperature at nearby faucet with candy or meat thermometer. Water temperature should be at least 120°F (50°C). Adjust water heater as necessary. • Avoid using hot water elsewhere before or during washer use. There may not be enough hot water available for proper cleaning. If problem persists, your hot water system may be unable to support more than 1 use at a time.
Water in washer does not drain or drains slowly	<ul style="list-style-type: none"> • Drain hose is kinked or clogged. 	<ul style="list-style-type: none"> • Clean and straighten the drain hose.
Water leaks	<ul style="list-style-type: none"> • Loose fill hose connection at faucet or washer. • House drain pipes are clogged. 	<ul style="list-style-type: none"> • Check and tighten hose connections. Install rubber sealing washers provided. • Unclog drain pipes. Contact plumber if necessary.
Incorrect wash and rinse temperatures	<ul style="list-style-type: none"> • Hot and cold water hoses are connected to wrong supply faucets. 	<ul style="list-style-type: none"> • Connect hot water hose to hot water faucet and cold water hose to cold water faucet.
Water is entering washer but tub does not fill	<ul style="list-style-type: none"> • Drain hose standpipe is incorrect height. 	<ul style="list-style-type: none"> • Standpipe must be a minimum of 33" (84 cm) high to prevent siphoning. See <i>Installation</i> section.
Water is present in tub after wash cycle is complete	<ul style="list-style-type: none"> • Lid lock malfunction. 	<ul style="list-style-type: none"> • DO NOT bypass lid lock. Call your authorized service provider.
The drain and spin cycles did not occur	<ul style="list-style-type: none"> • Lid lock malfunction. 	<ul style="list-style-type: none"> • DO NOT bypass lid lock. Call your authorized service provider.

52 LIMITED WARRANTY

For the applicable warranty period as set forth below, as measured from your original date of delivery, Electrolux will repair or replace any parts of this appliance that prove to be defective in materials or workmanship when such appliance is installed, used and maintained in accordance with the provided instructions.

Warranty Periods:

- All parts — One year including labor
- Wash tub — Functional life of the product (excluding labor)

Exclusions

This warranty does not cover the following:

1. Products with original serial numbers that have been removed, altered or cannot be readily determined.
2. Product that has been transferred from its original owner to another party or removed outside the USA or Canada.
3. Rust on the interior or exterior of the unit.
4. Products purchased “as-is” are not covered by this warranty.
5. Products used in a commercial setting.
6. Service calls which do not involve malfunction or defects in materials or workmanship, or for appliances not in ordinary household use or used other than in accordance with the provided instructions.
7. Service calls to correct the installation of your appliance or to instruct you how to use your appliance.
8. Expenses for making the appliance accessible for servicing, such as removal of trim, cupboards, shelves, etc., which are not a part of the appliance when it is shipped from the factory.
9. Service calls to repair or replace appliance light bulbs, air filters, water filters, other consumables, or knobs, handles, or other cosmetic parts.
10. Surcharges including, but not limited to, any after hour, weekend, or holiday service calls, tolls, ferry trip charges, or mileage expense for service calls to remote areas, including the state of Alaska.
11. Damages to the finish of appliance or home incurred during installation, including but not limited to floors, cabinets, walls, etc.
12. Damages caused by: services performed by unauthorized service companies; use of parts other than genuine Electrolux parts or parts obtained from persons other than authorized service companies; or external causes such as abuse, misuse, inadequate power supply, accidents, fires, or acts of God.

DISCLAIMER OF IMPLIED WARRANTIES; LIMITATION OF REMEDIES

CUSTOMER'S SOLE AND EXCLUSIVE REMEDY UNDER THIS LIMITED WARRANTY SHALL BE PRODUCT REPAIR OR REPLACEMENT AS PROVIDED HEREIN. CLAIMS BASED ON IMPLIED WARRANTIES, INCLUDING WARRANTIES OF MERCHANTABILITY OR FITNESS FOR A PARTICULAR PURPOSE, ARE LIMITED TO ONE YEAR OR THE SHORTEST PERIOD ALLOWED BY LAW, BUT NOT LESS THAN ONE YEAR. ELECTROLUX SHALL NOT BE LIABLE FOR CONSEQUENTIAL OR INCIDENTAL DAMAGES SUCH AS PROPERTY DAMAGE AND INCIDENTAL EXPENSES RESULTING FROM ANY BREACH OF THIS WRITTEN LIMITED WARRANTY OR ANY IMPLIED WARRANTY. SOME STATES AND PROVINCES DO NOT ALLOW THE EXCLUSION OR LIMITATION OF INCIDENTAL OR CONSEQUENTIAL DAMAGES, OR LIMITATIONS ON THE DURATION OF IMPLIED WARRANTIES, SO THESE LIMITATIONS OR EXCLUSIONS MAY NOT APPLY TO YOU. THIS WRITTEN WARRANTY GIVES YOU SPECIFIC LEGAL RIGHTS. YOU MAY ALSO HAVE OTHER RIGHTS THAT VARY FROM STATE TO STATE.

If You Need Service

Keep your receipt, delivery slip, or some other appropriate payment record to establish the warranty period should service be required. If service is performed, it is in your best interest to obtain and keep all receipts. Service under this warranty must be obtained by contacting Electrolux at the addresses or phone numbers below.

This warranty only applies in the USA and Canada. In the USA, your appliance is warranted by Electrolux Consumer Products, Inc. In Canada, your appliance is warranted by Electrolux Canada Corp. Electrolux authorizes no person to change or add to any obligations under this warranty. Obligations for service and parts under this warranty must be performed by Electrolux or an authorized service company. Product features or specifications as described or illustrated are subject to change without notice.

USA
1-800-374-4432
Frigidaire
10200 David Taylor Drive
Charlotte, NC 28262



Electrolux

Canada
1.800.265.8352
Electrolux Canada Corp.
5855 Terry Fox Way
Mississauga, Ontario, Canada
L5V 3E4

Though Frigidaire makes every effort to make replacement parts, repair services and information necessary to maintain or repair our products available to consumers, parts, service and information are not guaranteed, pursuant to section 39 of the Consumer Protection Act, CQLR, c. P-40.1 and sections 79.18 to 79.20 of the Regulation respecting the application of the Consumer Protection Act, CQLR, c P-40.1, r. 3.

If you need replacement parts, you may call us at 1 (800) 265-8352 for service in French or English, or purchase online at www.frigidaireapplianceparts.com



You may book repair services online at support.frigidaire.ca/repairs/information

Alternatively, our resource library is available at support.frigidaire.ca/support-articles to help you diagnose and resolve issues which may arise during the lifetime of your appliance.

Though most parts are available for purchase, subject to short-term availability constraints, the following appliances and parts are not serviceable.

Legend

Availability of replacement parts, repair services, and information for maintenance or repair.

	Partially Available
	Not Available
	Available

Washers and Dryers		Replacement parts, repair services, and information for repair and maintenance available.
---------------------------	---	---

FRIGIDAIRE®

welcome **home.**



Our home is your home. Visit us if you need help with any of these things:



owner support



accessories



service



registration

(See your registration card for more information.)

Frigidaire.com
1-800-374-4432

Frigidaire.ca
1-800-265-8352